

# Mod. **VP/P**

$Q = 140 \div 7200 \text{m}^3/\text{h}$

$Q = 0.04 \div 2 \text{m}^3/\text{s}$

$p_t = 100 \div 2000 \text{mmH}_2\text{O}$

$p_t = 1000 \div 20000 \text{Pa}$



**Campo di lavoro**

Portate basse. Pressioni alte.

**Tipo di pala**

Curva, positiva, vedi pag. 2.3.

**Applicazioni**

Per trasporto pneumatico, polveri, essiccazione, pressurizzazione. Adatto per impieghi nel campo industriale delle fonderie, pastifici, forni, chimico.

**Esecuzioni costruttive standard**

Es.1-Es.4-Es.5-Es.8-Es.9-Es.12, vedi pag. 2.5 - 2.6.

**Temperature del fluido standard**

-10÷+60°C. Per altre temperature vedi da pag. 1.12 a pag. 1.15.

**Tipo di costruzione**

Ventilatore in lamiera di Fe360, girante in Fe360 equilibrata staticamente e dinamicamente. Per altri materiali vedi da pag. 1.12 a pag. 1.15.

**Dati di funzionamento**

Condizioni dell'aria all'aspirazione T=20°C, 0m.s.l.m. e  $\rho=1.205 \text{ kg/m}^3$ .

**Rumorosità**

Espressa in potenza sonora  $L_{wA}$  [dB(A)] rilevata in campo libero con ventilatore canalizzato, vedi da pag. 1.43 a pag. 1.49.

**Orientamenti**

N°8 RD (rotazione oraria vista lato trasmissione) e N°8 LG. Ventilatore in versione imbullonata orientabile per le taglie 400-630, con supporto anteriore e quindi non orientabile dalla grandezza 710 a trasmissione, sempre orientabile nei ventilatori direttamente accoppiati senza supporto anteriore. Vedi pag. 2.7.

**Costruzioni speciali**

Vedi da pag. 2.20 a pag. 2.30.

**Avviamento ventilatore**

L'avviamento deve avvenire con ventilatore parzializzato, in funzione dell'assorbimento massimo del ventilatore.

**Classi giranti**

La seguente tabella fa riferimento a condizioni di lavoro standard. In condizioni di esercizio gravose si consiglia di contattare il servizio clienti di MORO per conoscere la tipologia di girante più idonea.

**Domaine de travail**

Faibles débits. Hautes pressions.

**Type d'ailette**

Courbée, positive, voir page 2.3.

**Applications**

Pour transport pneumatique, poussières, séchage, pressurisation. Convient à l'emploi dans le domaine industriel des fonderies, fabriques de pâtes, fours, chimique.

**Configurations de constructions standard**

Ex.1- Ex.4- Ex.5- Ex.8- Ex.9- Ex.12, voir pages 2.5 - 2.6.

**Températures du fluide standard**

-10 ÷ +60°C. Pour d'autres températures voir pages 1.12-1.15.

**Type de fabrication**

Ventilateur en tôle de Fe360, turbine en Fe360 équilibrée statiquement et dynamiquement. Pour d'autres matériaux, voir pages 1.12-1.15.

**Données de fonctionnement**

Conditions de l'air à l'aspiration T=20°C, 0 m asl et  $\rho=1.205 \text{ kg/m}^3$ .

**Niveau sonore**

Exprimé en puissance sonore  $L_{wA}$  [dB(A)], relevé à l'air libre avec un ventilateur canalisé, voir pages 1.43 - 1.49.

**Orientations**

8 RD (rotation dans le sens des aiguilles d'une montre côté transmission) et 8 LG. Ventilateur en version boulonnée orientable pour les tailles 400-630, avec un support avant et donc non orientable de la grandeur 710 à transmission, toujours orientable dans les ventilateurs directement accouplés sans support avant. Voir page 2.7.

**Fabrications spéciales**

Voir pages 2.20-2.30.

**Mise en marche du ventilateur**

Le démarrage doit se faire avec un ventilateur partialisé, en fonction de l'absorption maximale du ventilateur.

**Classes de turbines**

Le tableau ci-dessus fait référence aux conditions de travail normales, en conditions de travail pénibles, on préconise de contacter le service clientèle de MORO pour connaître le type de turbine le plus adapté.

GRANDEZZA VENTILATORE • Grandeur • Size • Größe • Tamaño	RPM MASSIMO • Maxi tours/min. • Max rpm • Max. U/min R.p.m. máx.		
	CLASSE I	CLASSE II	CLASSE III
VP400	5000		
VP450/R	5000		
VP450	5000		
VP500	5000		
VP560/R	5000		
VP560	4700	5000	
VP630/R	4400	4850	
VP630	4100	4550	5000
VP710/R	3700	4100	4500
VP710	3550	3850	4250
VP800/R	3400	3700	4000
VP800	3250	3550	3850
VP900/R	3100	3400	3700
VP900	2950	3250	3550

**VALORI VALIDI FINO A 60°C**

- Valeurs valables jusqu'à 60°C
- Values valid up to 60°C
- Werte bis 60°C gültig
- Valores válidos hasta 60°C

FRA • entre • between • zwischen • entre	60°C	E • et • and • und • y	100°C	DECLASSARE VELOCITÀ • déclasser vitesse • degrade speed • Geschwindigkeit herabsetzen • rebajar velocidad	4%
	100°C		150°C		10%
	150°C		200°C		16%
	200°C		250°C		23%
	250°C		300°C		30%
	300°C		350°C		37%
	350°C		400°C		45%
	400°C		450°C		54%
	450°C		500°C		64%

**Field of operation**

Low flow rates. High pressures.

**Blade type**

Curve, positive, see pg. 2.3.

**Applications**

For pneumatic transport, dust, drying, pressurization. Suitable for applications in industrial fields like foundries, pasta factories, bakeries, chemicals.

**Standard constructional arrangements**

Arr.1 - Arr.4 - Arr.5 - Arr.8 - Arr.9 - Arr.12, see pgs. 2.5 - 2.6.

**Standard fluid temperatures**

-10÷+60°C. For other temperatures see pgs. 1.12 to 1.15.

**Type of construction**

Fan in Fe360 plate, impeller in Fe360 statically and dynamically balanced. For other materials see pgs. 1.12 to 1.15.

**Operating specifications**

Condition of inlet air T=20°C, 0 m above sea level and  $\rho=1.205 \text{ kg/m}^3$ .

**Noise level**

Expressed as sound power  $L_{wA}$  [dB(A)] measured in free field with ducted fan, see pgs. 1.43 to 1.49.

**Orientations**

No.8 RD (clockwise viewed from transmission side) and No.8 LG. Fan in bolted orientable version for sizes 400-630, with front support and so not orientable for sizes 710 and above with transmission drive, always orientable for directly coupled fans without front support. See pg. 2.7.

**Special applications**

See pgs. 2.20 to 2.30.

**Fan start-up**

During start-up the fan flow rate must be limited, calibrated for the fan's maximum electrical input.

**Impeller classes**

The above table refers to standard operating conditions, in heavy-duty service conditions it is advisable to contact the MORO Customer Service to establish the most suitable type of impeller.

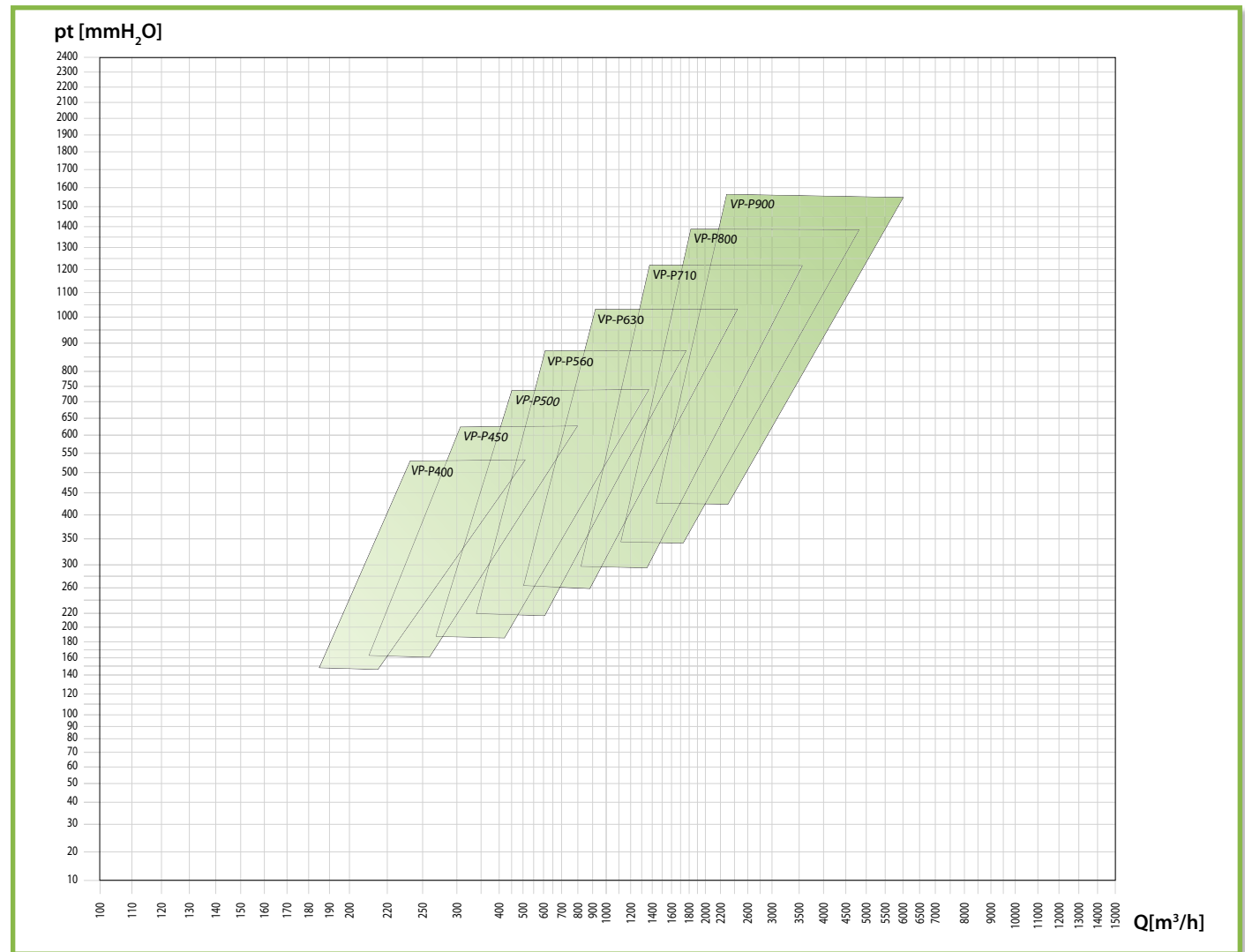

### Arbeitsbereich

Niedrige Fördermengen. Hohe Drücke.

#### Schweifform

positive Kurve, siehe Seite 2.3.

#### Anwendungen

Zum Transport von Stäuben, zur Trocknung und für mit Überdruck zu beaufschlagende Räume. Zur Verwendung im industriellen Bereich, Giessereien, Nudelfabriken, Öfen und der Chemie geeignet.

#### Konstruktive Standardausführungen

Ausf. 1-Ausf. 4-Ausf. 5-Ausf. 8-Ausf. 9-Ausf. 12, siehe Seiten 2.5 - 2.6.

#### Standardtemperatur des Mediums

-10 ÷ +60°C. Für andere Temperaturen siehe Seiten 1.12 bis 1.15.

#### Konstruktionsart

Ventilator aus Blech Fe360, Laufrad aus Fe360, statisch und dynamisch ausgewuchtet. Für andere Materialien siehe Seiten 1.12 bis 1.15.

#### Betriebsdaten

Physikalischer Zustand der Ansaugluft T = 20°C, 0 m ü. M. und  $\rho = 1.205 \text{ kg/m}^3$ .

#### Geräuschpegel

Angegeben als Schalleistungspegel  $L_{w,A}$  [dB(A)] mit Messung im Freifeld und an Rohren angeschlossenem Ventilatore, siehe Seiten 1.43 bis 1.49.

#### Ausrichtung

8 Modelle RD (Drehrichtung im Uhrzeigersinn, von Antriebsseite aus gesehen) und 8 Modelle LG. Angeschraubter, in der Ausrichtung veränderbarer Ventilator in den Grössen 400-630, mit Vorderstütze und damit nicht veränderbar ab Grösse 710 mit Riementrieb, immer ausrichtbar bei allen direkt angetriebenen Ventilatoren ohne Vorderstütze, siehe Seite 2.7.

#### Spezialausführungen

Siehe Seiten 2.20 bis 2.30.

#### Ventilator-Anlauf

Der Ventilatoranlauf muss bei teilweise geschlossenem Ventilator erfolgen, in Abhängigkeit von der maximalen Stromaufnahme des Motors.

#### Laufradklassen

Die obstehende Tabelle bezieht sich auf normale Betriebsbedingungen. Bei erschwerenden Betriebsbedingungen wird empfohlen, den Kundenservice der MORO zu kontaktieren, um den am besten geeigneten Laufradtyp zu bestimmen.

### Campo de trabajo

Caudales bajos. Presiones altas.

#### Tipo de pala

Curva, positiva, ver pág. 2.3.

#### Aplicaciones

Para transporte neumático, polvos, desecación y presurización. Apto para el uso en el campo industrial: fundiciones, fábricas de pasta, hornos e industria química.

#### Variantes constructivas estándares

Ejec. 1-Ejec. 4-Ejec. 5-Ejec. 8-Ejec. 9-Ejec. 12, ver págs. 2.5 - 2.6.

#### Temperaturas del fluido estándares

De -10 a +60°C. Para otras temperaturas, ver págs. de 1.12 a 1.15.

#### Tipo de construcción

Ventilador de chapa en Fe360, rotor en Fe360 equilibrado estática y dinámicamente. Para otros materiales, ver págs. de 1.12 a 1.15.

#### Datos de funcionamiento

Condiciones del aire en aspiración T = 20°C, 0 m SNM y  $\rho = 1.205 \text{ kg/m}^3$ .

#### Niveles de ruido

Expresados en potencia sonora  $L_{w,A}$  [dB(A)] medida en campo abierto con ventilador canalizado, ver págs. de 1.43 a 1.49.

#### Orientaciones

8 RD (rotación dextrógira vista desde el lado de transmisión) y 8 LG. Ventilador en versión empennada orientable para tamaños 400-630, con soporte delantero, por lo cual no es orientable a partir del tamaño 710 de transmisión, siempre orientable en ventiladores acoplados directamente sin soporte delantero. Ver pág. 2.7.

#### Construcciones especiales

Ver págs. de 2.20 a 2.30.

#### Puesta en marcha del ventilador

La puesta en marcha debe efectuarse con ventilador parcializado, en función de la absorción máxima del ventilador.

#### Clases de rotores

La tabla arriba hace referencia a condiciones de trabajo estándares, en condiciones de funcionamiento pesadas, se aconseja llamar al Servicio de atención al cliente de MORO para conocer el tipo de rotor más adecuado.

Tipo • Type • Type • Typ • Tipo		P inst. [kW]	n	LpA [dB(A)]	Tolleranza sulla portata ±5% • Tolérance sur le débit ±5% • Load tolerance ±5% • Durchsatztoleranz ±5% • Tolerancia respecto caudal ±5%													
Ventilatore • Ventilateur • Fan • Ventilator Ventilador	Motore • Moteur • Motor • Motor Motor				Q [m³/h]													
					216	252	288	324	360	400	430	470	540	650	720	790	865	
		pt[mmH <sub>2</sub> O]																
VP400/P2	80	0,75	2845	64	304	310	315	320	323	326	327	328	327					
VP400/P2	80	1,1	2845	65	304	310	315	320	323	326	327	328	327	317	306	292		
VP450/P2	90	1,5	2900	68			397	403	408	414	418	422	428	433	433	431	427	
VP450/P2	90	2,2	2920	69			401	407	412	418	422	426	432	437	437	435	431	
VP500/P2R	90	2,2	2920	70					443	449	453	458	465	473	476	477	476	
VP500/P2R	100	3	2920	71					443	449	453	458	465	473	476	477	476	
VP500/P2	100	3	2920	71						495	500	506	515	527	532	536	540	
VP500/P2	112	4	2950	72						505	510	516	525	537	542	546	550	
VP560/P2R	112	4	2950	73								567	577	590	598	604	610	
VP560/P2R	132	5,5	2950	74								567	577	590	598	604	610	
VP560/P2	132	5,5	2950	75										646	654	662	669	
VP560/P2	132	7,5	2950	76										646	654	662	669	
VP630/P2R	132	5,5	2950	75												720	729	
VP630/P2R	132	7,5	2950	76												720	729	
VP630/P2	132	7,5	2950	75														
VP630/P2	160	11	2950	77														
VP710/P2R	160	11	2950	77														
VP710/P2R	160	15	2950	78														
VP710/P2	160	15	2950	79														
VP710/P2	160	18,5	2960	81														
VP710/P2	180	22	2960	81														
VP800/P2R	180	22	2960	80														
VP800/P2R	200	30	2960	81														
VP800/P2	200	30	2960	81														
VP800/P2	200	37	2960	84														
VP900/P2R	200	37	2960	81														
VP900/P2R	225	45	2960	85														
VP900/P2R	250	55	2960	85														
VP900/P2	250	55	2960	87														
VP900/P2	280	75	2970	87														

Il livello di pressione sonora ponderato A, LpA (cap.14), corrisponde al valore rilevato, nelle condizioni di prova, nel punto di massima rumorosità.

**Tolleranza sulla rumorosità ±4dB(A)**

• Tolérance sur le bruit ±4dB(A) • Noise tolerance ±4dB(A)  
 • Geräuschtoleranz ±4dB(A) • Tolerancia respecto a ruido ±4dB(A)

Q [m³/h]

935	1080	1225	1370	1440	1620	1800	2160	2520	2880	3240	3600	3960	4320	4680	5400	6120	7200	8280	9400
pt[mmH <sub>2</sub> O]																			
420																			
424	403																		
473	461																		
473	461	441	412																
541	539	531	516	506															
551	549	541	526	516	486														
614	619	619	614	609	593														
614	619	619	614	609	593	569													
675	684	690	691	691	685	673													
675	684	690	691	691	685	673	629												
736	748	757	764	766	767	764													
736	748	757	764	766	767	764	742	699											
818	833	846	857	861	869	874	872												
818	833	846	857	861	869	874	872	854	821	772									
	921	936	949	954	967	977	988	988	975										
	921	936	949	954	967	977	988	988	975	950	913	862							
				1043	1065	1079	1099	1110	1112	1104	1087								
				1049	1071	1085	1105	1116	1118	1110	1093	1066	1030						
				1049	1071	1085	1105	1116	1118	1110	1093	1066	1030	983					
								1240	1260	1273	1282	1278	1274	1257	1239				
								1240	1260	1273	1282	1278	1274	1257	1239	1162			
								1349	1374	1394	1408	1417	1420	1418	1409	1373			
								1349	1374	1394	1408	1417	1420	1418	1409	1373	1314	1176	
									1517	1542	1563	1580	1592	1600	1603	1596	1570		
									1517	1542	1563	1580	1592	1600	1603	1596	1570	1496	
									1517	1542	1563	1580	1592	1600	1603	1596	1570	1496	1377
									1692	1718	1740	1758	1773	1785	1797	1794	1763	1698	
									1698	1724	1746	1764	1779	1791	1803	1800	1769	1704	1600

■ Le niveau de pression sonore pondérée A, LpA (chap. 14), correspond à la valeur relevée dans les conditions d'essai au point de niveau sonore maximum.

■ The A-weighted sound power level, LpA (Chap.14), is the value measured in test conditions at the point of maximum noise level.

■ Der nach A bewertete Schalldruckpegel LpA (Kap. 14) entspricht in den Testbedingungen dem höchsten gemessenen Wert des Geräuschpegels.

■ El nivel de presión sonora ponderado A, LpA (cap. 14), corresponde al valor medido, en las condiciones de prueba, en el punto con máximos niveles de ruido.

Tipo • Type • Type • Typ • Tipo		P inst. [kW]	n	LpA [dB(A)]	Tolleranza sulla portata ±5% • Tolérance sur le débit ±5% • Load tolerance ±5% • Durchsatztoleranz ±5% • Tolerancia respecto caudal ±5%													
Ventilatore • Ventilateur • Fan • Ventilator Ventilador	Motore • Moteur • Motor • Motor Motor				Q [m³/h]													
					216	252	288	324	360	400	430	470	540	650	720	790	865	
		pt[mmH <sub>2</sub> O]																
VP400/P2	80	0,75	2845	64	293	298	301	305	306	307	307	306	301					
VP400/P2	80	1,1	2845	65	293	298	301	305	306	307	307	306	301	285	269	250		
VP450/P2	90	1,5	2900	68			379	384	388	393	395	398	401	401	398	392	384	
VP450/P2	90	2,2	2920	69			383	388	392	396	399	402	405	405	401	396	388	
VP500/P2R	90	2,2	2920	70					422	427	430	434	439	443	444	442	439	
VP500/P2R	100	3	2920	71					422	427	430	434	439	443	444	442	439	
VP500/P2	100	3	2920	71						469	473	478	484	492	495	496	497	
VP500/P2	112	4	2950	72						478	482	487	493	501	504	505	506	
VP560/P2R	112	4	2950	73								534	542	552	558	562	566	
VP560/P2R	132	5,5	2950	74								534	542	552	558	562	566	
VP560/P2	132	5,5	2950	75										602	608	614	618	
VP560/P2	132	7,5	2950	76										602	608	614	618	
VP630/P2R	132	5,5	2950	75												668	675	
VP630/P2R	132	7,5	2950	76												668	675	
VP630/P2	132	7,5	2950	75														
VP630/P2	160	11	2950	77														
VP710/P2R	160	11	2950	77														
VP710/P2R	160	15	2950	78														
VP710/P2	160	15	2950	79														
VP710/P2	160	18,5	2960	81														
VP710/P2	180	22	2960	81														
VP800/P2R	180	22	2960	80														
VP800/P2R	200	30	2960	81														
VP800/P2	200	30	2960	81														
VP800/P2	200	37	2960	84														
VP900/P2R	200	37	2960	81														
VP900/P2R	225	45	2960	85														
VP900/P2R	250	55	2960	85														
VP900/P2	250	55	2960	87														
VP900/P2	280	75	2970	87														

Il livello di pressione sonora ponderato A, LpA (cap.14), corrisponde al valore rilevato, nelle condizioni di prova, nel punto di massima rumorosità.

**Tolleranza sulla rumorosità ±4dB(A)**

• Tolérance sur le bruit ±4dB(A) • Noise tolerance ±4dB(A)  
 • Geräuschtoleranz ±4dB(A) • Tolerancia respecto a ruido ±4dB(A)

Q [m³/h]

935	1080	1225	1370	1440	1620	1800	2160	2520	2880	3240	3600	3960	4320	4680	5400	6120	7200	8280	9400
pt[mmH <sub>2</sub> O]																			
373																			
377	347																		
433	416																		
433	416	390	354																
495	487	473	451	437															
504	496	482	460	446	407														
567	568	563	553	546	524														
567	568	563	553	546	524	494													
622	626	626	622	619	606	587													
622	626	626	622	619	606	587	528												
680	688	693	696	696	692	685													
680	688	693	696	696	692	685	654	601											
751	761	770	776	778	781	780	767												
751	761	770	776	778	781	780	767	737	693	631									
		851	860	863	871	876	878	870	849										
		851	860	863	871	876	878	870	849	817	772	714							
				937	953	961	971	971	963	946	920								
				942	958	966	976	976	968	951	925	888	843						
				942	958	966	976	976	968	951	925	888	843	786					
							1094	1105	1109	1110	1100	1088	1066	1042					
							1094	1105	1109	1110	1100	1088	1066	1042	956				
							1180	1195	1205	1210	1210	1204	1194	1178	1128				
							1180	1195	1205	1210	1210	1204	1194	1178	1128	1056	898		
								1312	1327	1339	1348	1352	1353	1350	1332	1297			
								1312	1327	1339	1348	1352	1353	1350	1332	1297	1214		
								1312	1327	1339	1348	1352	1353	1350	1332	1297	1214	1088	
									1440	1456	1468	1476	1482	1486	1483	1466	1419	1341	
									1444	1460	1472	1481	1487	1490	1487	1471	1423	1345	1229

■ Le niveau de pression sonore pondérée A, LpA (chap. 14), correspond à la valeur relevée dans les conditions d'essai au point de niveau sonore maximum.

■ The A-weighted sound power level, LpA (Chap.14), is the value measured in test conditions at the point of maximum noise level.

■ Der nach A bewertete Schalldruckpegel LpA (Kap. 14) entspricht in den Testbedingungen dem höchsten gemessenen Wert des Geräuschpegels.

■ El nivel de presión sonora ponderado A, LpA (cap. 14), corresponde al valor medido, en las condiciones de prueba, en el punto con máximos niveles de ruido.



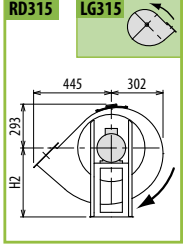
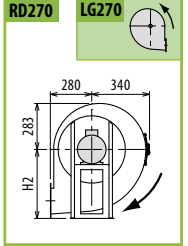
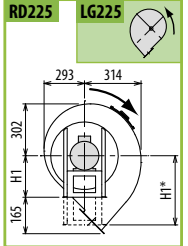
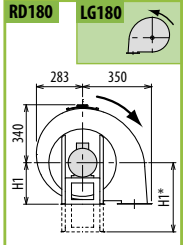
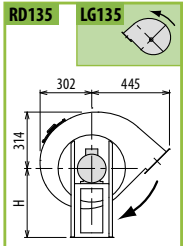
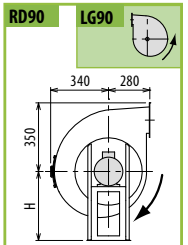
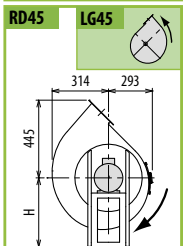
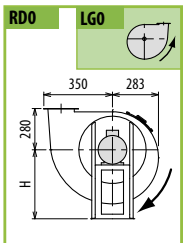
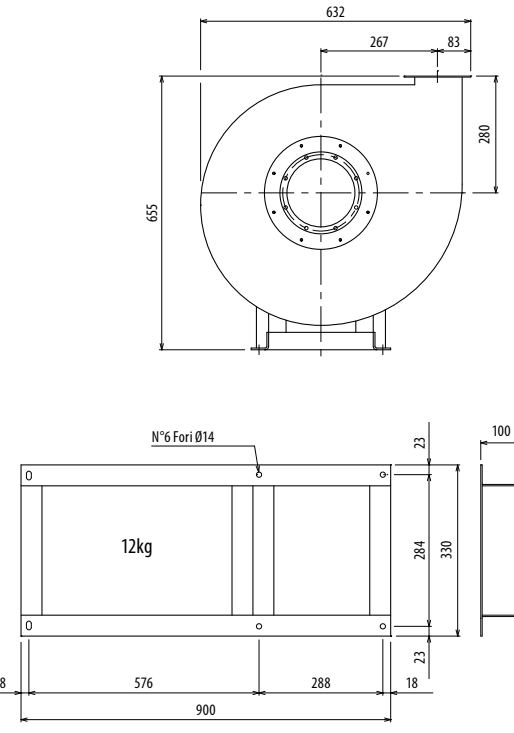
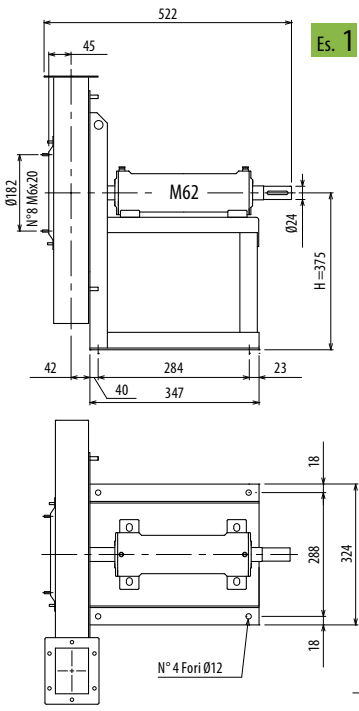
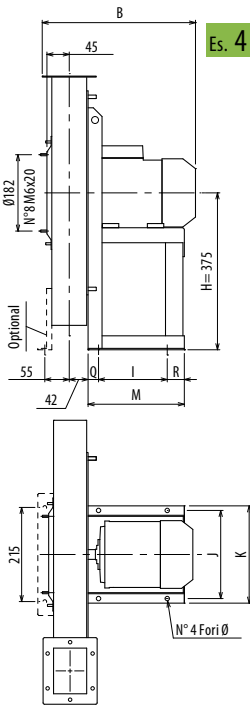

Il ventilatore è orientabile • Peso in tabella comprensivo di motore

- Le ventilateur est orientable
- The fan is revolvable
- Der Ventilator ist drehbar
- El ventilador es orientable
- Weitere Infos und Größen:
- Más informaciones y medidas:

Ulteriori informazioni e quote:  
 ■ Ulérieures informations et cotes:  
 ■ Further information and sizes:  
 ■ Weitere Infos und Größen:  
 ■ Más informaciones y medidas:

TIPO • Type		PESO Weight Kg	PD² Kgf x m²	B	I	H	H1	H2	J	K	M	Q	R	Ø
VENTILATORE Fan	MOTORE Motor			kg	Kgf x m²									
VP400/P2	80 A2	49	0,5	344	121	375	375*	375	203	225	211	45	45	10
VP400/P2	80 B2	49	0,5	344	121	375	375*	375	203	225	211	45	45	10
VP400/P/T		40	0,50			375	280	375						

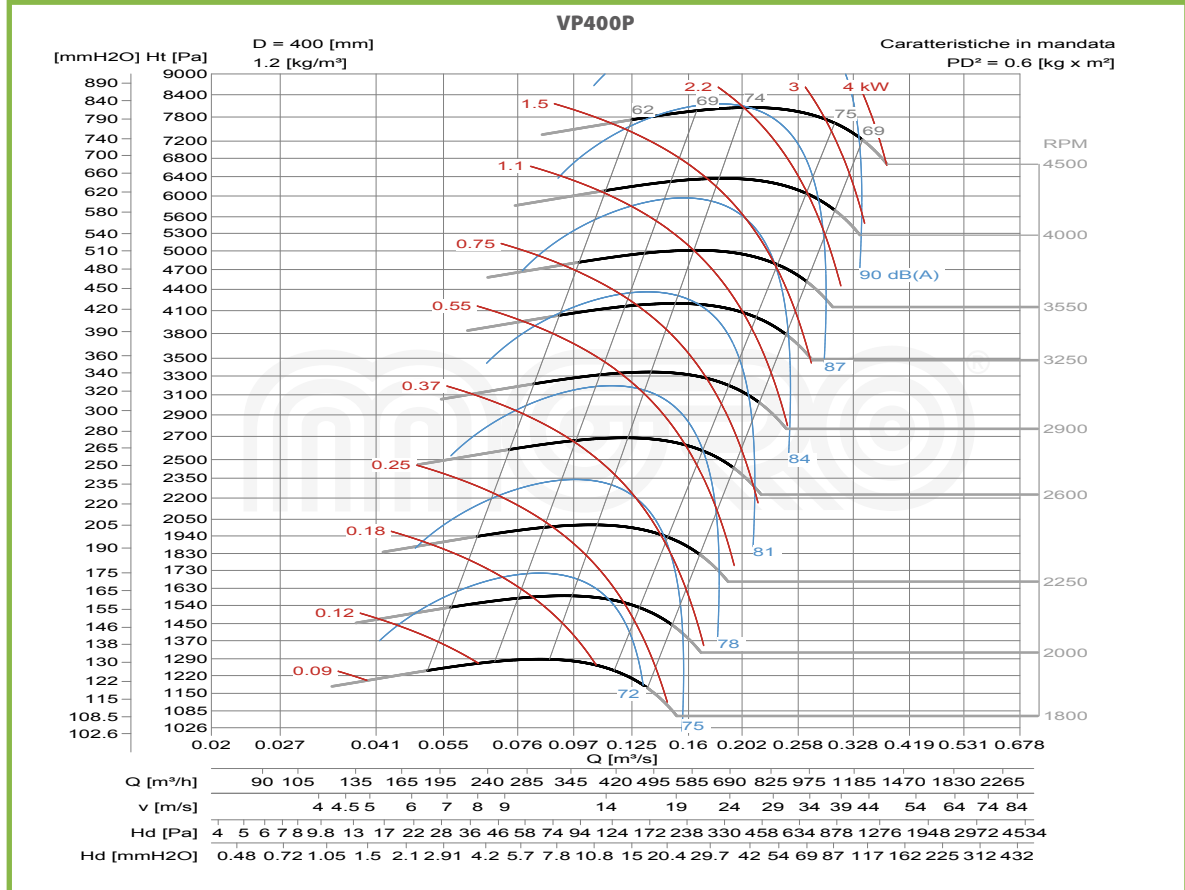
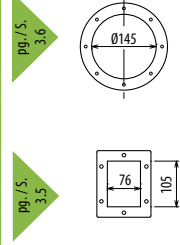



# DIMENSIONI D'INGOMBRO E PESI/CURVE DI FUNZIONAMENTO

■ DIMENSIONS D'ENCOMBREMENT ET POIDS/COURBES DE FONCTIONNEMENT ■ OVERALL DIMENSIONS AND WEIGHT/WORKING CURVES  
 ■ AUSMAßE UND GEWICHTE/FUNKTIONSKURVEN ■ DIMENSIONES QUE OCUPA Y PESOS/CURVAS DE FUNCIONAMIENTO

# VP450/P

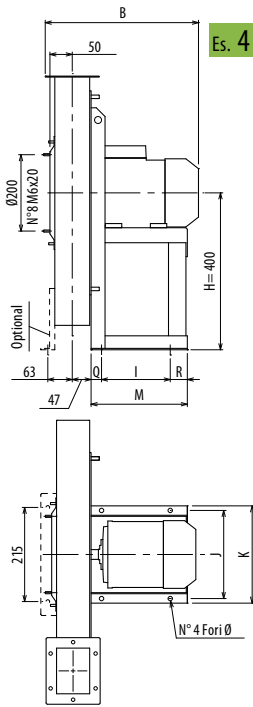

Es. 4

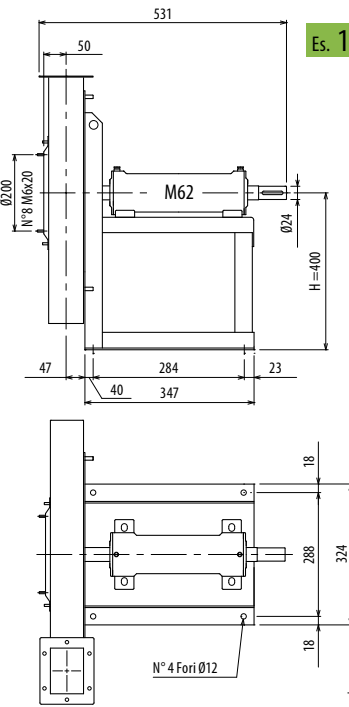

Es. 1

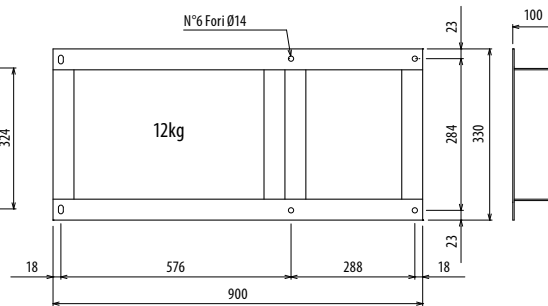
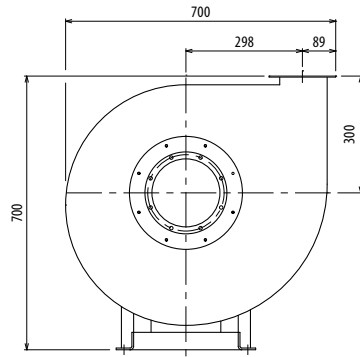

Il ventilatore è orientabile - Peso in tabella comprensivo di motore

- Le ventilateur est orientable
- The fan is revolvable
- Der Ventilator ist drehbar
- El ventilador es orientable
- Le poids dans le tableau inclut le moteur
- The weight indicated in the table includes motor
- Gewichtsangabe in Tabelle inkl. Motor
- El peso en la tabla incluye el motor

Ulteriori informazioni e quote:  
 ■ Ulérieures informations et cotes:  
 ■ Further information and sizes:  
 ■ Weitere Infos und Größen:  
 ■ Más informaciones y medidas:

TIPO - Type		PESO Weight Kg	PD <sup>2</sup> Kg f x m <sup>2</sup>	B	I	H	H1	H2	J	K	M	Q	R	Ø
VENTILATORE Fan	MOTORE Motor													
VP450/P2	90 S2	58	0,9	400	133	400	400*	400	234	260	246	55	58	10
VP450/P2	90 L2	61	0,9	400	133	400	400*	400	234	260	246	55	58	10
VP450/P/T		65	0,9			400	300	400						

pg. / s.  
3.6

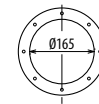

pg. / s.  
3.5

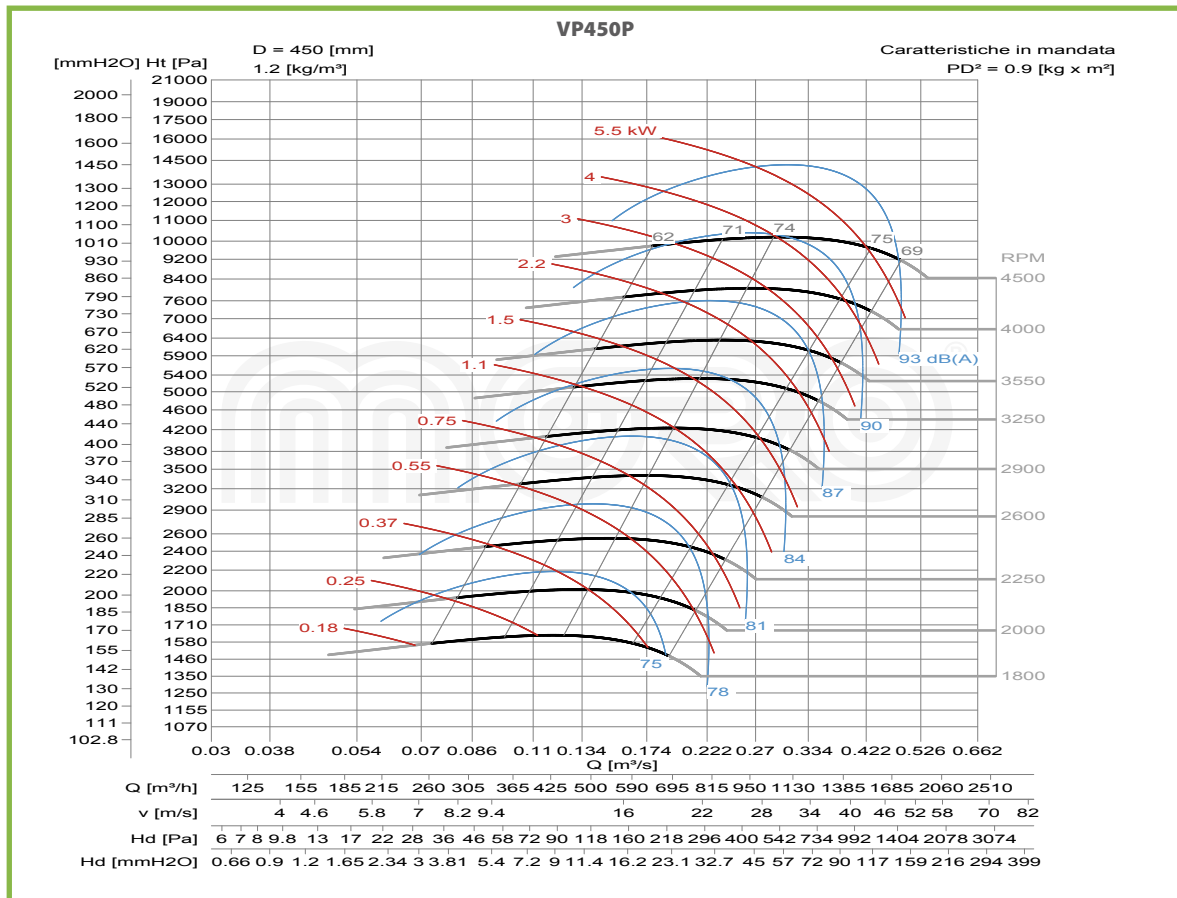
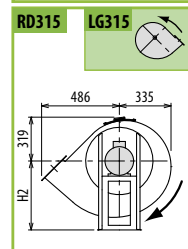
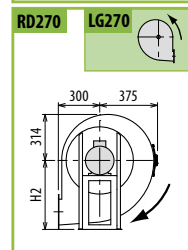
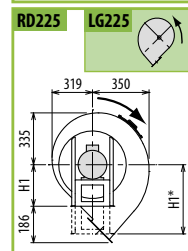
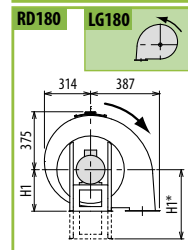
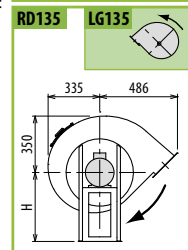
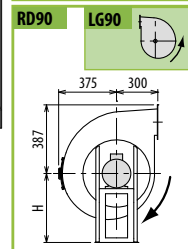
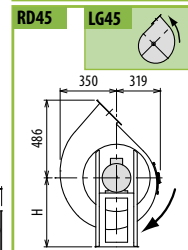
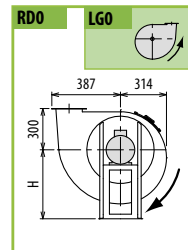

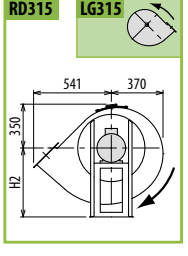
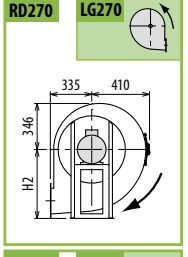
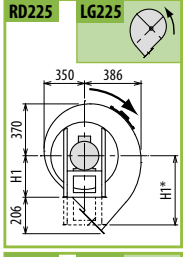
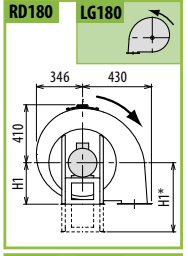
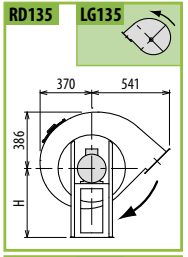
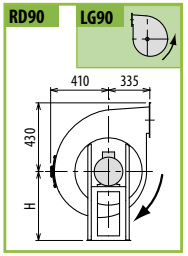
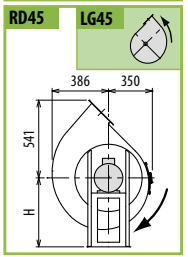
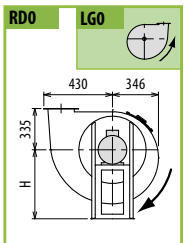
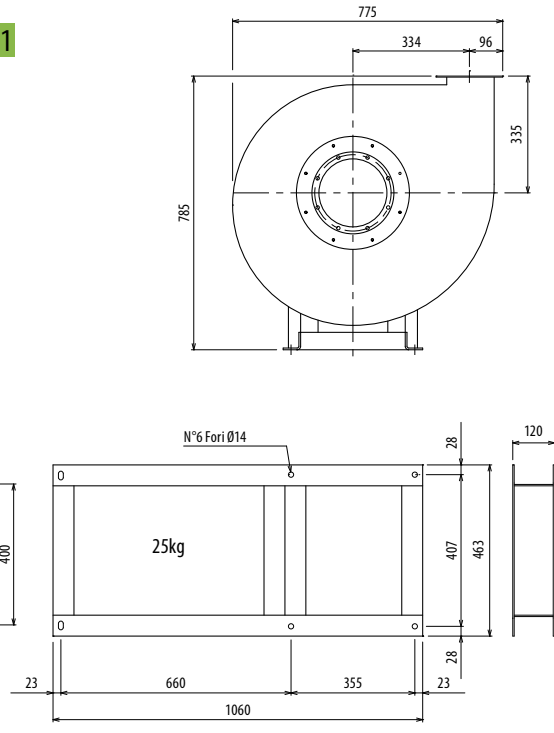
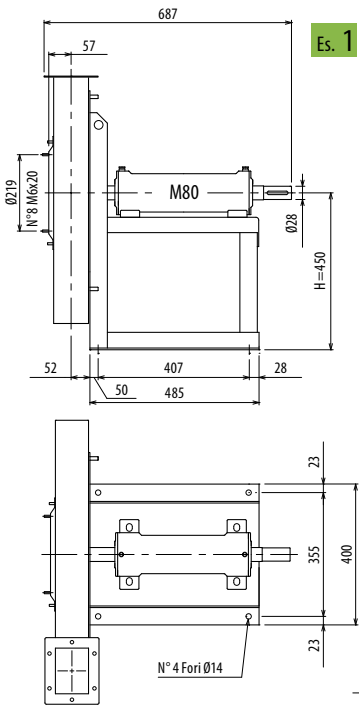
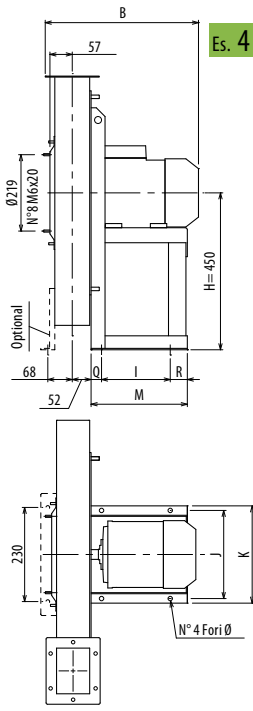

Il ventilatore è orientabile • Peso in tabella comprensivo di motore

- Le ventilateur est orientable
- Der Ventilator ist drehbar
- El ventilador es orientable
- Weitere Infos und Größen:
- Más informaciones y medidas:

Ulteriori informazioni e quote:  
 ■ Ulérieures informations et cotes:  
 ■ Further information and sizes:  
 ■ Weitere Infos und Größen:  
 ■ Más informaciones y medidas:

TIPO • Type		PESO Weight Kg	PD² Kgf x m²	B	I	H	H1	H2	J	K	M	Q	R	Ø
VENTILATORE Fan	MOTORE Motor													
VP500/P2R	90 L2	65	1,2	410	133	450	450*	450	234	260	246	55	58	10
VP500/P2R	100 L2	74	1,2	441	197	450	450*	450	289	324	276	30	49	12
VP500/P2	100 L2	77	1,4	441	197	450	450*	450	289	324	276	30	49	12
VP500/P2	112 M2	85	1,4	462	197	450	450*	450	289	324	276	30	49	12
VP500/P/T		80	1,4			450	335	450						

pg. / s. 3.6

pg. / s. 3.5

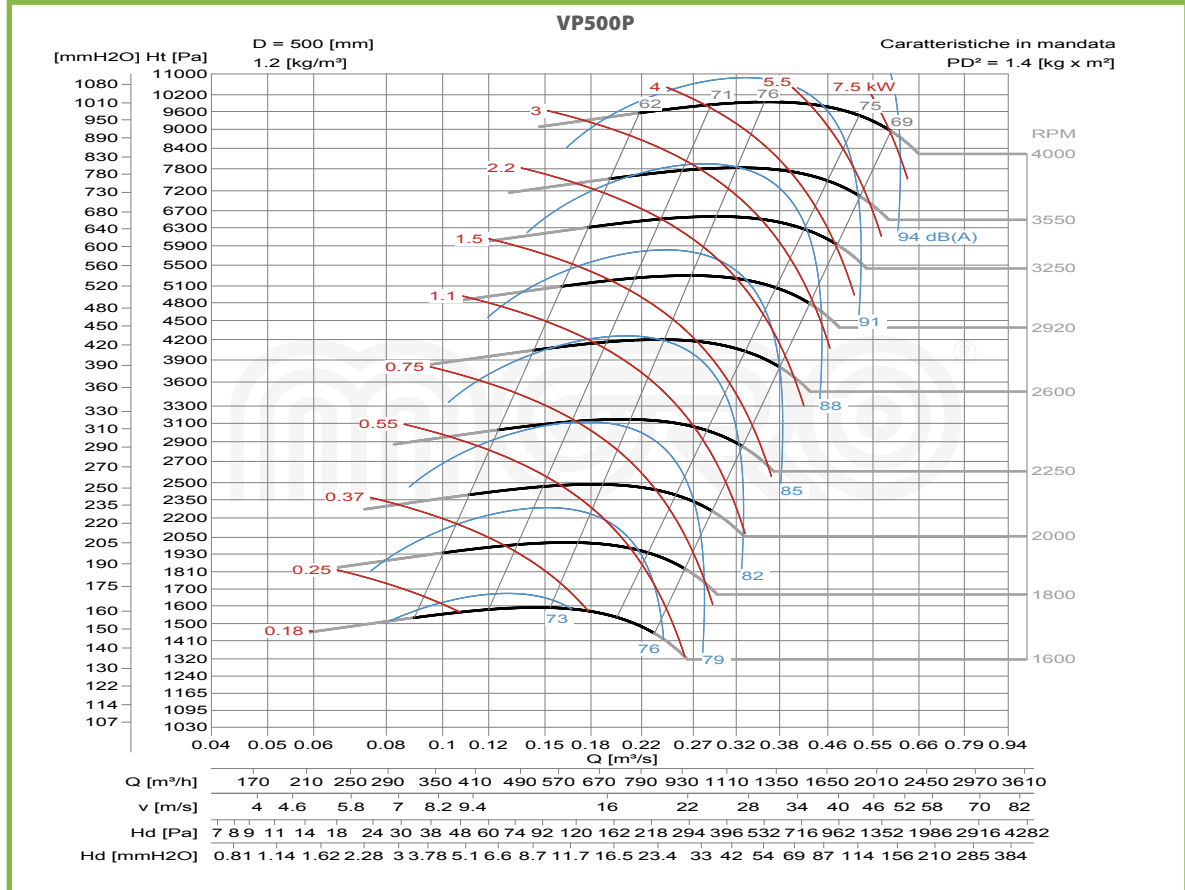
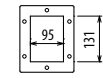
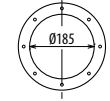

VP/P

# DIMENSIONI D'INGOMBRO E PESI/CURVE DI FUNZIONAMENTO

■ DIMENSIONS D'ENCOMBREMENT ET POIDS/COURBES DE FONCTIONNEMENT ■ OVERALL DIMENSIONS AND WEIGHT/WORKING CURVES  
 ■ AUSMAßE UND GEWICHTE/FUNKTIONSKURVEN ■ DIMENSIONES QUE OCUPA Y PESOS/CURVAS DE FUNCIONAMIENTO

# VP560/P

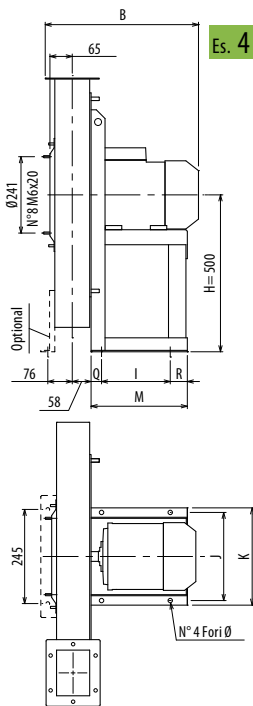

Es. 4

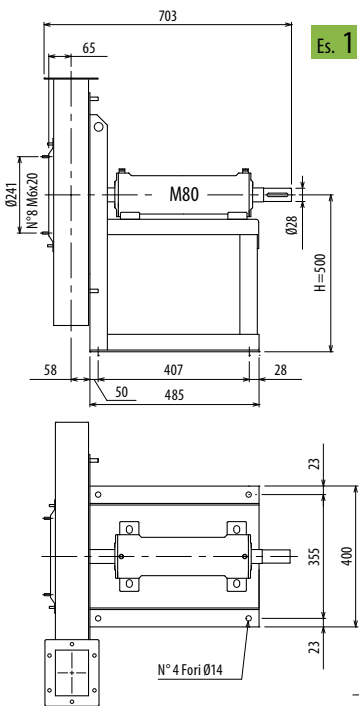

Es. 1

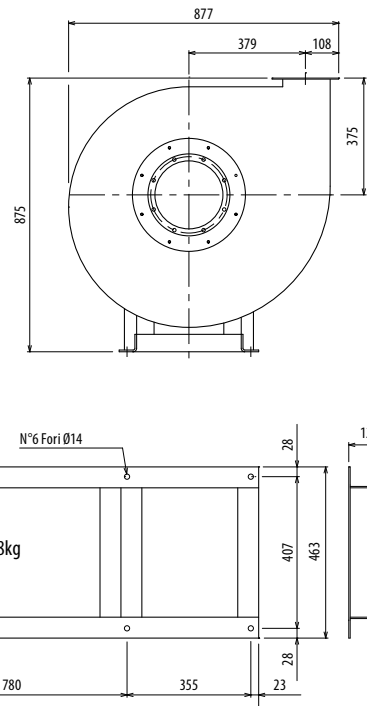

Il ventilatore è orientabile • Peso in tabella comprensivo di motore

- Le ventilateur est orientable
- The fan is revolvable
- Der Ventilator ist drehbar
- El ventilador es orientable
- Le poids dans le tableau inclut le moteur
- The weight indicated in the table includes motor
- Gewichtsangabe in Tabelle inkl. Motor
- El peso en la tabla incluye el motor

Ulteriori informazioni e quote:  
 ■ Ulteriores informations et cotes:  
 ■ Further information and sizes:  
 ■ Weitere Infos und Größen:  
 ■ Más informaciones y medidas:

TIPO • Type		PESO Weight Kg	PD <sup>2</sup> Kgf x m <sup>2</sup>	B	I	H	H1	H2	J	K	M	Q	R	Ø
VENTILATORE Fan	MOTORE Motor													
VP560/P2R	112 M2	106	1,7	478	197	500	500*	500	289	324	276	30	49	12
VP560/P2R	132 SA2	120	1,7	518	237	500	500*	500	337	372	336	40	59	12
VP560/P2	132 SA2	122	2,2	518	237	500	500*	500	337	372	336	40	59	12
VP560/P2	132 SB2	122	2,2	518	237	500	500*	500	337	372	336	40	59	12
VP560/P/T		100	2,2			500	375	500						

pg. / s. 3.6

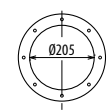

pg. / s. 3.5

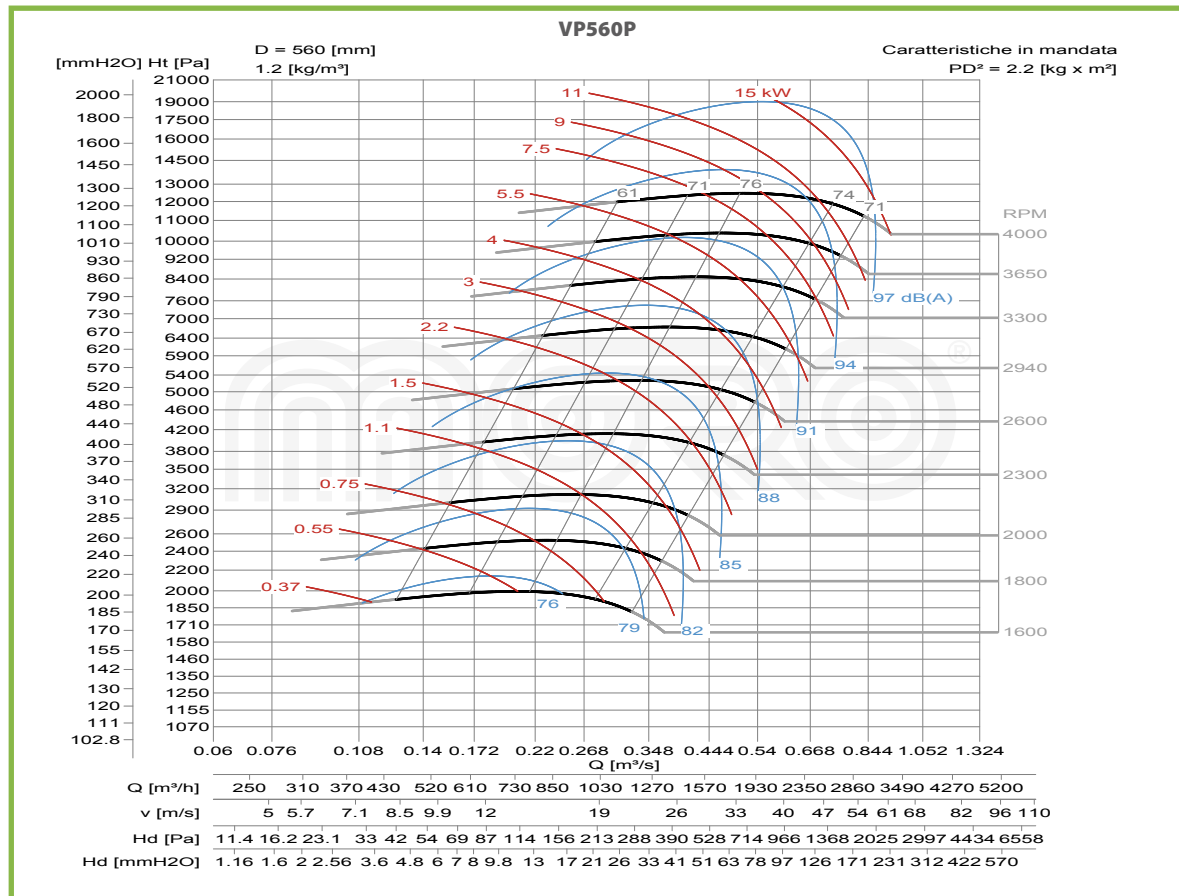
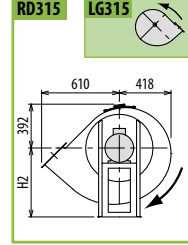
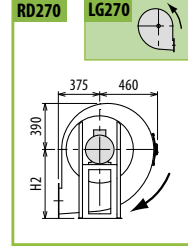
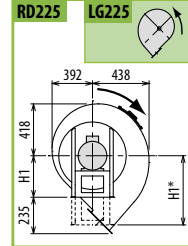
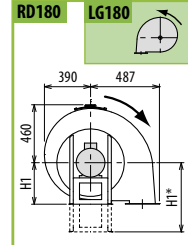
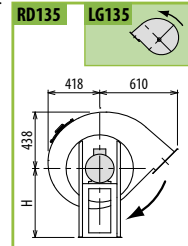
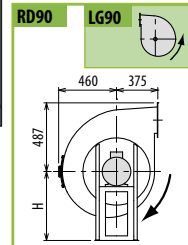
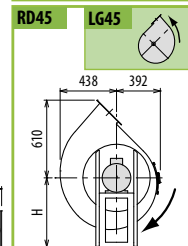
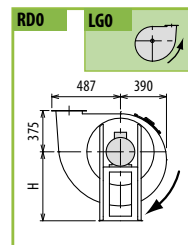
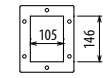

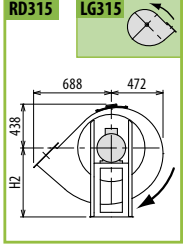
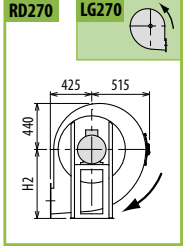
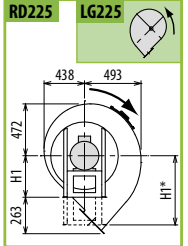
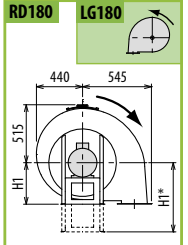
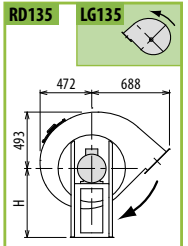
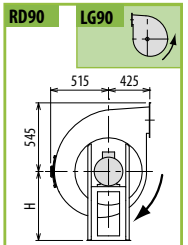
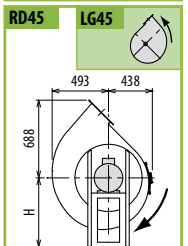
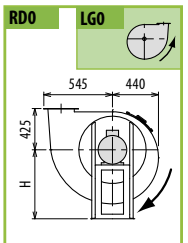
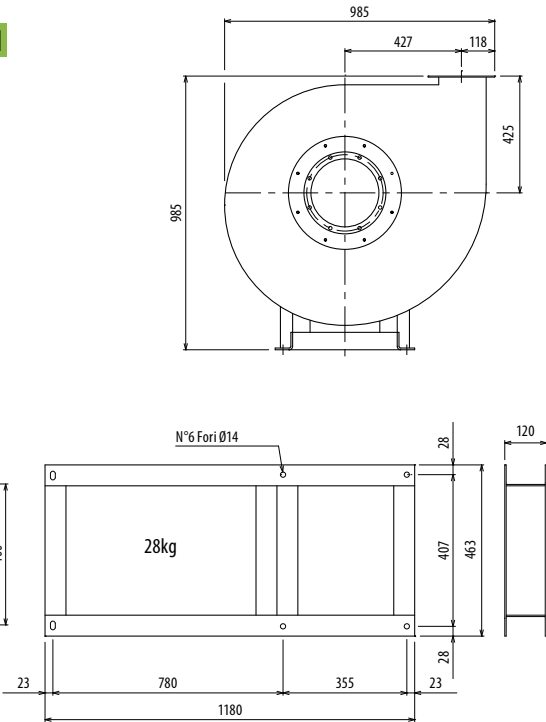
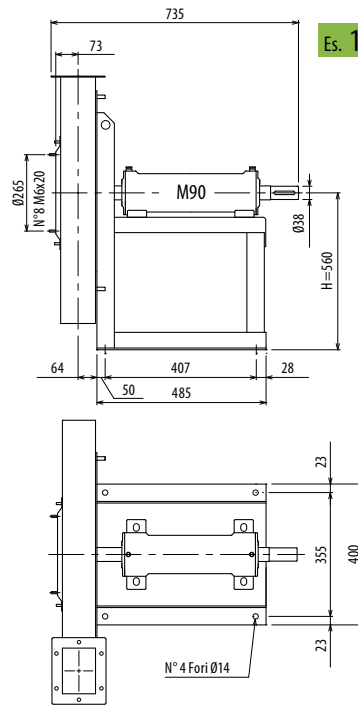
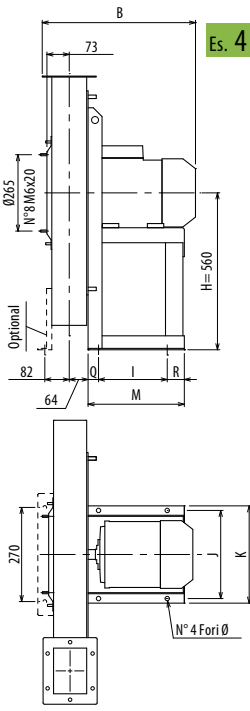

Il ventilatore è orientabile • Peso in tabella comprensivo di motore

- Le ventilateur est orientable
- The fan is revolvable
- Der Ventilator ist drehbar
- El ventilador es orientable
- Le poids dans le tableau inclut le moteur
- The weight indicated in the table includes motor
- Gewichtsangabe in Tabelle inkl. Motor
- El peso en la tabla incluye el motor

Ulteriori informazioni e quote:  
 ■ Ulérieures informations et cotes:  
 ■ Further information and sizes:  
 ■ Weitere Infos und Größen:  
 ■ Más informaciones y medidas:

TIPO • Type		PESO Weight Kg	PD <sup>2</sup> Kgf x m <sup>2</sup>	B	I	H	H1	H2	J	K	M	Q	R	Ø
VENTILATORE Fan	MOTORE Motor													
VP630/P2R	132 SA2	146	3	530	237	560	560*	560	337	372	336	40	59	12
VP630/P2R	132 SB2	146	3	530	237	560	560*	560	337	372	336	40	59	12
VP630/P2	132 SB2	148	3,8	530	237	560	560*	560	337	372	336	40	59	12
VP630/P2	160 MA2	182	3,8	635	337	560	560*	560	395	440	436	50	49	14
VP630/P/T		133	3,8			560	425	560						

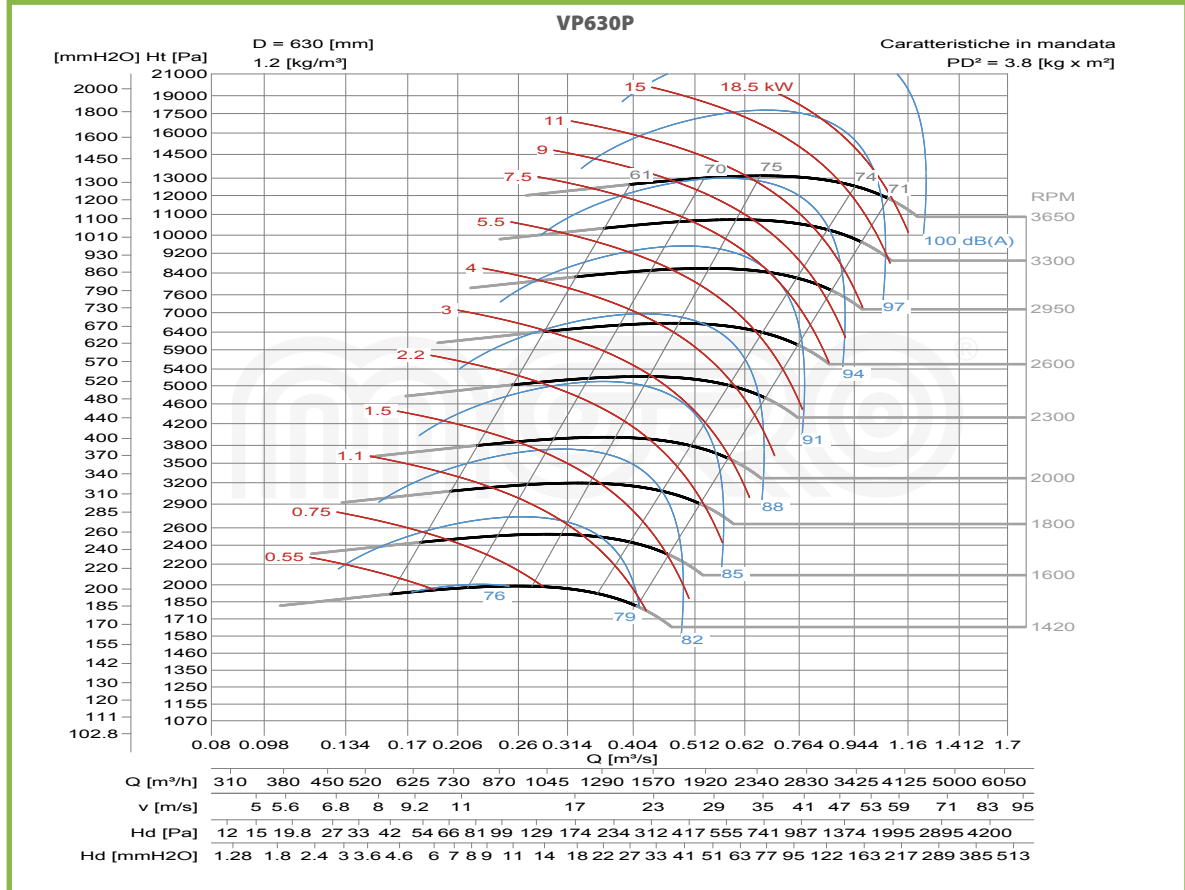
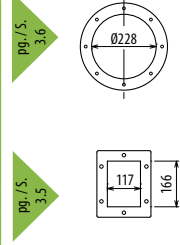

VP/P

# DIMENSIONI D'INGOMBRO E PESI/CURVE DI FUNZIONAMENTO

■ DIMENSIONS D'ENCOMBRE ET POIDS/COURBES DE FONCTIONNEMENT ■ OVERALL DIMENSIONS AND WEIGHT/WORKING CURVES  
 ■ AUSMAß UND GEWICHTE/FUNKTIONSKURVEN ■ DIMENSIONES QUE OCUPA Y PESOS/CURVAS DE FUNCIONAMIENTO

## VP710/P

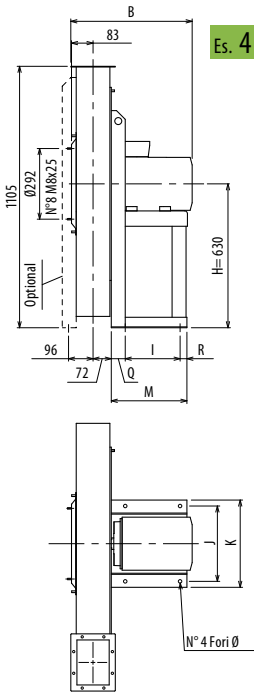

Es. 4

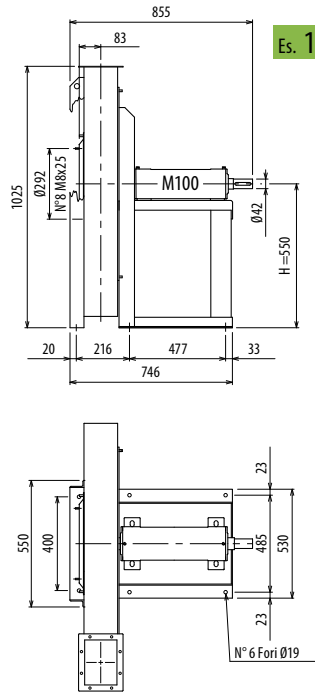

Es. 1

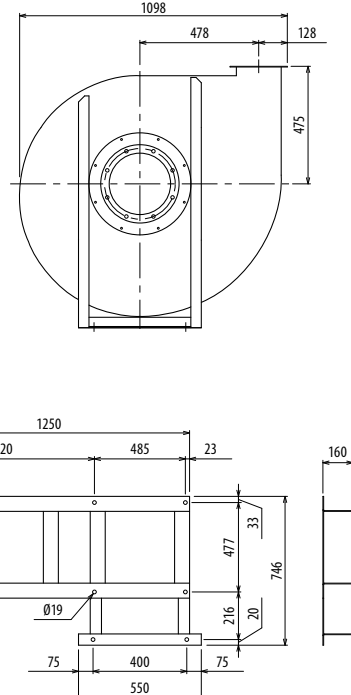

Il ventilatore in ES. 4 senza supporto anteriore è orientabile, in ES. 1 non è orientabile - Peso in tabella comprensivo di motore

- Le ventilateur en Ex. 4 sans support frontal est orientable, en Ex. 1 n'est pas orientable. ■ The fan in Ex. 4 without front support is revolvable, in Ex. 1 is not revolvable.
- Le poids dans le tableau inclut le moteur ■ The weight indicated in the table includes motor
- Der Ventilator in Aus. 4, ohne Vorderhalterung, ist drehbar, in Aus. 1 ist nicht drehbar. ■ El ventilador en Ej. 4 sin soporte delantero es orientable, en Ej. 1 no es orientable.
- Das Gewicht im Tafel schließt den Motor ein ■ El peso en la tabla incluye el motor

Ulteriori informazioni e quote:  
 ■ Ulérieures informations et cotes:  
 ■ Further information and sizes:  
 ■ Weitere Infos und Größen:  
 ■ Más informaciones y medidas:

TIPO - Type		PESO Weight Kg	PD <sup>2</sup> Kgf x m <sup>2</sup>	B	I	H	H1	H2	J	K	M	Q	R	Ø
VENTILATORE Fan	MOTORE Motor													
VP710/P2R	160 MA2	218	5,5	650	337	630*	630*	630	395	440	436	50	49	14
VP710/P2R	160 MB2	218	5,5	650	337	630*	630*	630	395	440	436	50	49	14
VP710/P2	160 MB2	221	6,7	650	337	630*	630*	630	395	440	436	50	49	14
VP710/P2	160 L2	233	6,7	650	337	630*	630*	630	395	440	436	50	49	14
VP710/P2	180 M2	290	6,7	731	357	630*	630*	630	434	488	460	70	33	17
VP710/P/T		183	6,7			550	475	630						

pg. / s. 3,6



pg. / s. 3,5

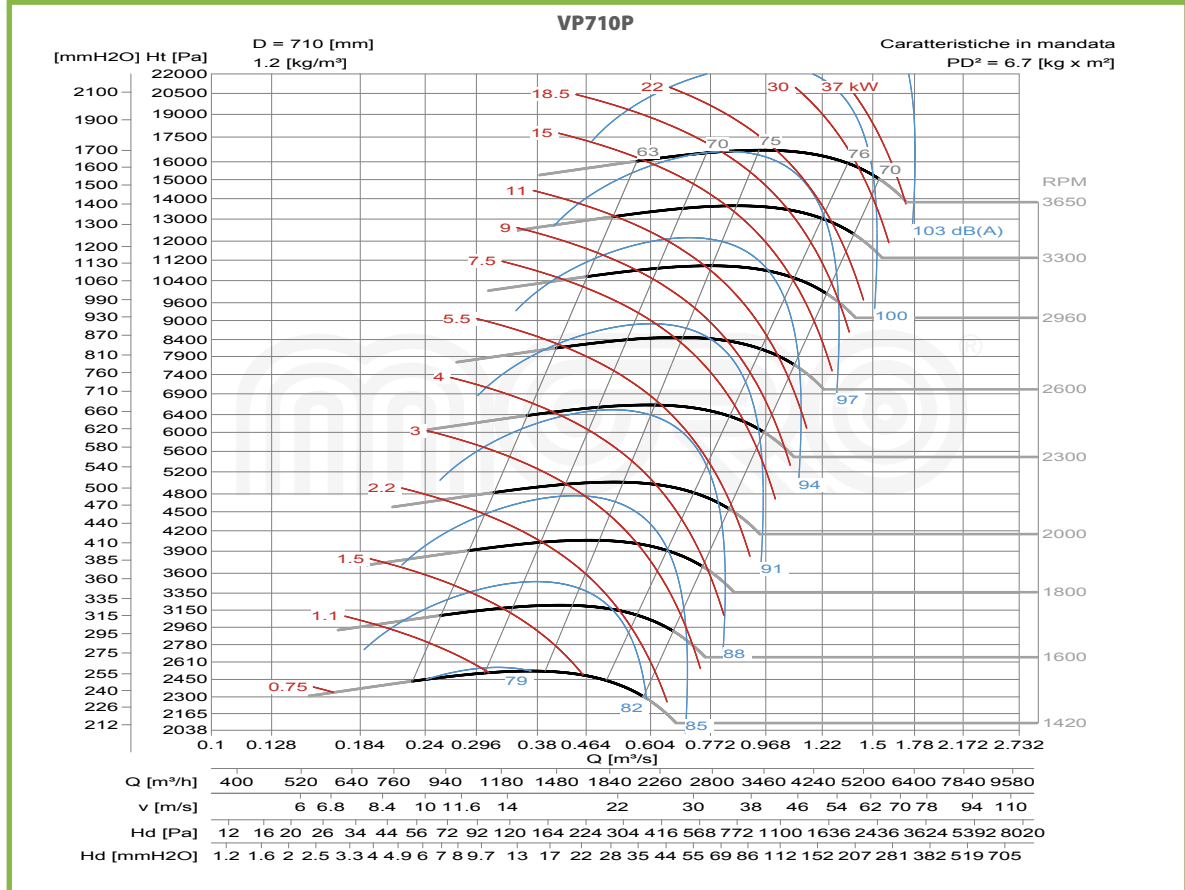
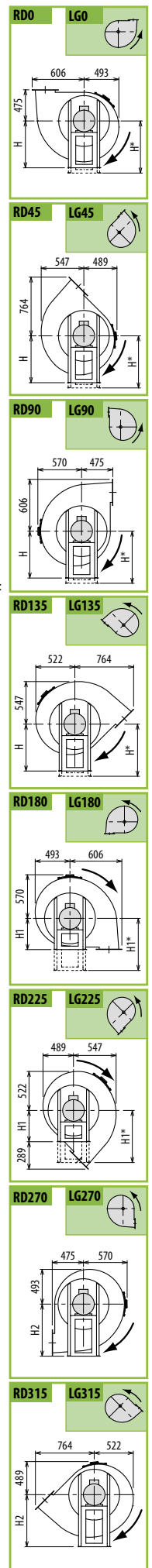



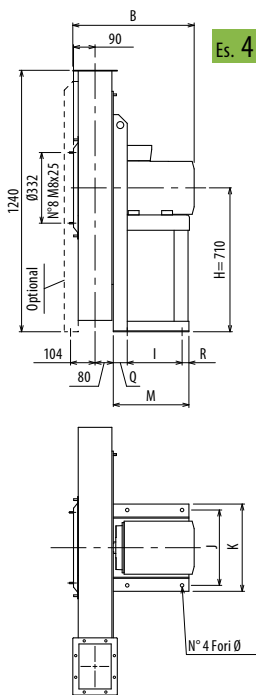

Es. 4

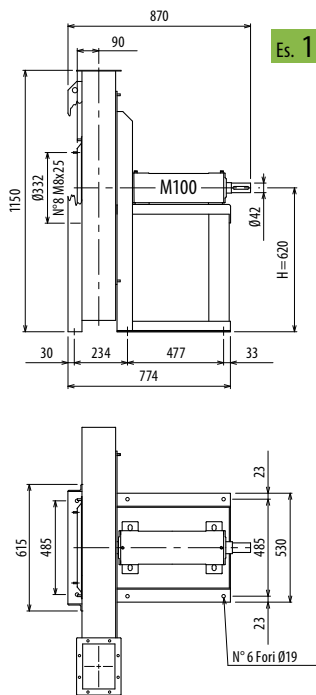

Es. 1

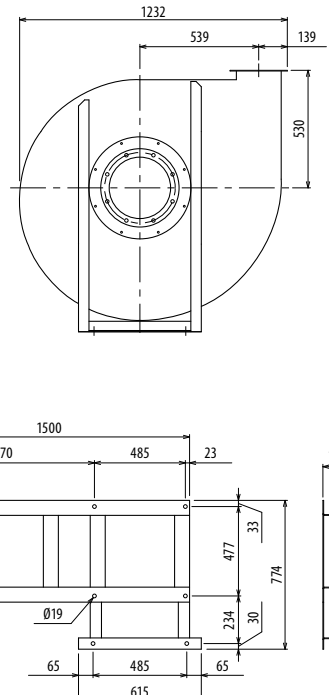

Il ventilatore in ES. 4 senza supporto anteriore è orientabile, in ES. 1 non è orientabile - Peso in tabella comprensivo di motore

- Le ventilateur en Ex. 4 sans support frontal est orientable, en Ex. 1 n'est pas orientable. ■ The fan in Ex. 4 without front support is revolvable, in Ex. 1 is not revolvable.
- Le poids dans le tableau inclut le moteur ■ The weight indicated in the table includes motor
- Der Ventilator in Aus. 4, ohne Vorderhalterung, ist drehbar; in Aus. 1 ist nicht drehbar. ■ El ventilador in Aus. 4 sin soporte delantero es orientable, en Ej. 1 no es orientable.
- Das Gewicht in Tafel schließt den Motor ein ■ El peso en la tabla incluye el motor

Ulteriori informazioni e quote:  
 ■ Ulterieurs informations et cotes:  
 ■ Further information and sizes:  
 ■ Weitere Infos und Größen:  
 ■ Más informaciones y medidas:

TIPO - Type		PESO Weight Kg	PD <sup>2</sup> Kg f x m <sup>2</sup>	B	I	H	H1	H2	J	K	M	Q	R	Ø
VENTILATORE Fan	MOTORE Motor													
VP800/P2R	180 M2	325	8,6	748	357	710*	710*	710	434	488	460	70	33	17
VP800/P2R	200 LA2	414	8,6	856	381	710*	710*	710	506	568	500	80	39	19
VP800/P2	200 LA2	421	11	856	381	710*	710*	710	506	568	500	80	39	19
VP800/P2	200 LB2	421	11	856	381	710*	710*	710	506	568	500	80	39	19
VP800/P/T		218	11			620	530	710						

pg. / s. 3,6



pg. / s. 3,5

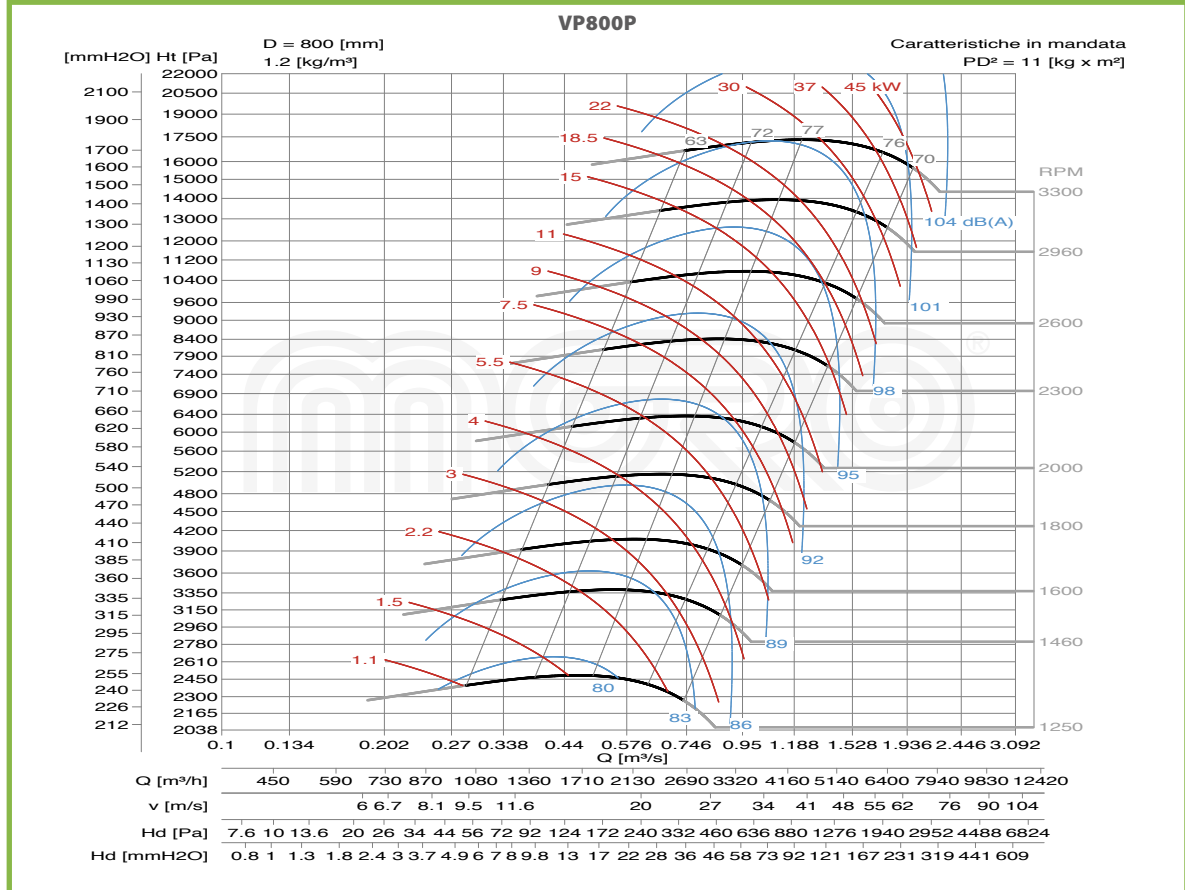
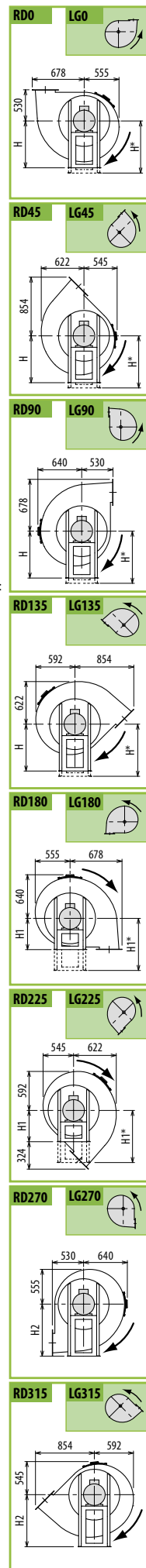

# DIMENSIONI D'INGOMBRO E PESI/CURVE DI FUNZIONAMENTO

■ DIMENSIONS D'ENCOMBRE ET POIDS/COURBES DE FONCTIONNEMENT ■ OVERALL DIMENSIONS AND WEIGHT/WORKING CURVES  
 ■ AUSMAß UND GEWICHTE/FUNKTIONSKURVEN ■ DIMENSIONES QUE OCUPA Y PESOS/CURVAS DE FUNCIONAMIENTO

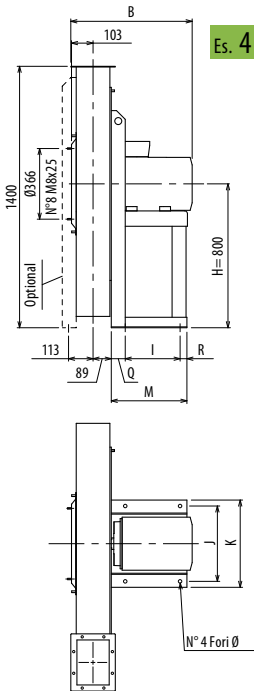

Es. 4

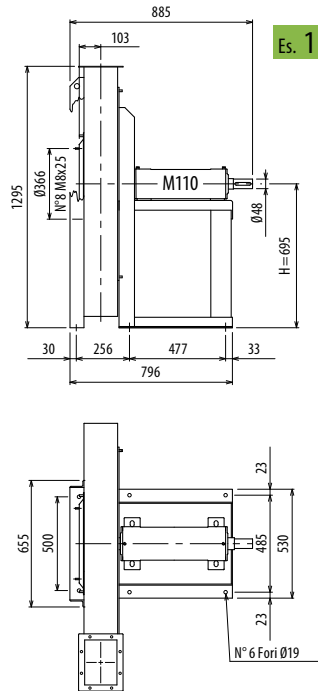

Es. 1

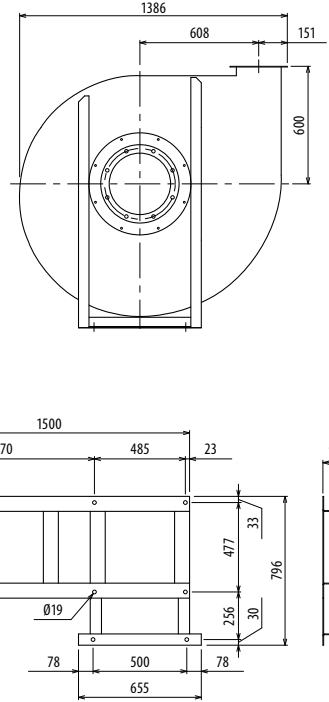

Il ventilatore in Es. 4 senza supporto anteriore è orientabile, in Es. 1 non è orientabile - Peso in tabella comprensivo di motore

- Le ventilateur en Ex. 4 sans support frontal est orientable, en Ex. 1 n'est pas orientable. ■ The fan in Ex. 4 without front support is revolvable, in Ex. 1 is not revolvable.
- Le poids dans le tableau inclut le moteur The weight indicated in the table includes motor
- Der Ventilator in Aus. 4, ohne Vorderhalterung, ist drehbar; in Aus. 1 ist nicht drehbar. ■ El ventilador en Ej. 4 sin soporte delantero es orientable, en Ej. 1 no es orientable.
- Das Gewicht im Tafel schließt den Motor ein El peso en la tabla incluye el motor

Ulteriori informazioni e quote:  
 ■ Ulérieures informations et cotes:  
 ■ Further information and sizes:  
 ■ Weitere Infos und Größen:  
 ■ Más informaciones y medidas:

TIPO - Type		PESO Weight Kg	PD <sup>2</sup> Kgf x m <sup>2</sup>	B	I	H	H1	H2	J	K	M	Q	R	Ø
VENTILATORE Fan	MOTORE Motor													
VP900/P2R	200 LB2	542	14	874	381	800*	800*	800	506	568	500	80	39	19
VP900/P2R	225 M2	622	14	916	421	800*	800*	800	556	616	540	80	39	19
VP900/P2R	250 M2	743	14	1024	501	800*	800*	800	604	690	600	60	39	19
VP900/P2	250 M2	746	19	1024	501	800*	800*	800	604	690	600	60	39	19
VP900/P2	280 S2	876	19	1027	591	800*	800*	800	690	750	697	60	46	21
VP900/P/T		320	19			695	600	800						

pg. / s. 3.6



pg. / s. 3.5



**RD0 LG0**

**RD45 LG45**

**RD90 LG90**

**RD135 LG135**

**RD180 LG180**

**RD225 LG225**

**RD270 LG270**

**RD315 LG315**

