

Mod. **VC/N**

$Q = 150 \div 10000 \text{m}^3/\text{h}$

$Q = 0.04 \div 2.8 \text{m}^3/\text{s}$

$p_t = 160 \div 2850 \text{mmH}_2\text{O}$

$p_t = 1600 \div 28000 \text{Pa}$



Campo di lavoro

Portate medio-basse. Pressioni alte.

Tipo di pala

Curva, rovescia (negativa), vedi pag. 2.2.

Applicazioni

Per trasporto pneumatico, polveri, essiccazione, pressurizzazione. Adatto per impieghi nel campo industriale delle fonderie, pastifici, forni, chimico.

Esecuzioni costruttive standard

Es.1-Es.4-Es.5-Es.8-Es.9-Es.12, vedi pag. 2.5 - 2.6.

Temperature del fluido standard

-10÷+60°C. Per altre temperature vedi da pag. 1.12 a pag. 1.15.

Tipo di costruzione

Ventilatore in lamiera di Fe360, girante in Fe360 equilibrata staticamente e dinamicamente. Per altri materiali vedi da pag. 1.12 a pag. 1.15.

Dati di funzionamento

 Condizioni dell'aria all'aspirazione T=20°C, 0m.s.l.m. e ρ=1.205 kg/m³.

Rumorosità

 Espressa in potenza sonora L_{wA} [dB(A)] rilevata in campo libero con ventilatore canalizzato, vedi da pag. 1.43 a pag. 1.49.

Orientamenti

N°8 RD (rotazione oraria vista lato trasmissione) e N°8 LG. Ventilatore in versione imbullonata, orientabile, dalla grandezza 500 alla 630, con supporto anteriore e quindi non orientabile dalla grandezza 710 a trasmissione, sempre orientabile nei ventilatori direttamente accoppiati senza supporto anteriore. Vedi pag. 2.7.

Costruzioni speciali

Vedi da pag. 2.20 a pag. 2.30.

Avviamento ventilatore

I ventilatori serie VC devono necessariamente essere avviati con aspirazione completamente chiusa.

Verificare con i dati del costruttore del motore elettrico l'effettivo numero di avviamenti/ora che è in grado di sopportare il motore; salvo diverse indicazioni considerare un massimo di un avviamento/ora.

In caso sia prevista la necessità di avviare il ventilatore più frequentemente è possibile avviare installando un motore di taglia superiore. In avviamento la corrente di spunto può arrivare fino a 7 volte la corrente nominale, dimensionare in maniera opportuna la componentistica elettrica.

Classi giranti

La seguente tabella fa riferimento a condizioni di lavoro standard. In condizioni di esercizio gravose si consiglia di contattare il servizio clienti di MORO per conoscere la tipologia di girante più idonea.

■ **Domaine de travail:** Débits moyens-faibles. Hautes pressions.

Type d'ailette: Courbée, inversée (négative), voir page 2.2.

Applications: Pour transport pneumatique, poussières, séchage, pressurisation. Convient à l'emploi dans le domaine industriel des fonderies, fabriques de pâtes, fours, chimique.

Configurations de constructions standard: Ex.1- Ex.4- Ex.5- Ex.8- Ex.9- Ex.12, voir pages 2.5 - 2.6.

Températures du fluide standard: -10÷+60°C. Pour d'autres températures voir pages 1.12-1.15.

Type de fabrication: Ventilateur en tôle de Fe360, turbine en Fe360 équilibrée statiquement et dynamiquement. Pour d'autres matériaux, voir pages 1.12-1.15.

Données de fonctionnement: Conditions de l'air à l'aspiration T=20°C, 0 m asl et ρ=1.205 kg/m³.

Niveau sonore: Exprimé en puissance sonore L_{wA} [dB(A)], relevé à l'air libre avec un ventilateur canalisé, voir pages 1.43 - 1.49.

Orientations: 8 RD (rotation dans le sens des aiguilles d'une montre côté transmission) et 8 LG. Ventilateur en version boulonnée orientable pour les tailles 500-630, avec un support avant et donc non orientable de la grandeur 710 à transmission, toujours orientable dans les ventilateurs directement accouplés sans support avant. Voir page 2.7.

Fabrications spéciales: Voir pages 2.20-2.30.

Mise en marche du ventilateur: Les ventilateurs série VC doivent nécessairement être mis en marche avec une aspiration totalement fermée.

Vérifier le nombre réel de mises en marche/heure avec les données du constructeur du moteur électrique, que le moteur est en mesure de supporter. Sauf indications contraires, considérer un maximum de mise en marche/heure. S'il est prévu que le ventilateur doit être mis en marche plus fréquemment, on peut remédier en installant un moteur de dimension supérieure.

A la mise en marche, le courant de démarrage peut arriver à 7 fois le courant nominal, prévoir une installation électrique de dimension adaptée à cet effet.

Classes de turbines: Le tableau ci-dessus fait référence aux conditions de travail normales, en conditions de travail pénibles, on préconise de contacter le service clientèle de MORO pour connaître le type de turbine le plus adapté.

GRANDEZZA VENTILATORE • Grandeur • Size • Größe • Tamaño	RPM MASSIMO • Maxi tours/min. • Max rpm • Max. U/min • R.p.m. máx.		
	CLASSE I	CLASSE II	CLASSE III
VC500	5000		
VC560/R	5000		
VC560	4700	5000	
VC630/R	4400	4850	
VC630	4100	4550	5000
VC710/R	3700	4100	4500
VC710	3550	3850	4250
VC800/R	3400	3700	4000
VC800	3250	3550	3850
VC900/R	3100	3400	3700
VC900	2950	3250	3550
VC1000/R	3100	3550	3850
VC1000	3300	3550	3900
VC1120/R	3200	3450	3700
VC1120	3000	3250	3500
VC1250	2650	2800	3000

VALORI VALIDI FINO A 60°C

 • Valeurs valables jusqu'à 60°C • Values valid up to 60°C
 • Werte bis 60°C gültig • Valores válidos hasta 60°C

FRA • entre • between • zwischen • entre	60°C	E • et • and • und • y	100°C	DECLASSARE VELOCITÀ • déclasser vitesse • degrade speed • Geschwindigkeit herabsetzen • rebajar velocidad	4%
			100°C		150°C
	150°C		200°C		16%
	200°C		250°C		23%
	250°C		300°C		30%
	300°C		350°C		37%
	350°C		400°C		45%
	400°C		450°C		54%
	450°C		500°C		64%

■ **Field of operation:** Medium-low flow rates. High pressures.

Blade type: Curve, backward (negative), see pg. 2.2.

Applications: For pneumatic transport, dust, drying, pressurization. Suitable for applications in industrial fields like foundries, pasta factories, bakeries, chemicals.

Standard constructional arrangements: Arr.1 - Arr.4 - Arr.5 - Arr.8 - Arr.9 - Arr.12, see pgs. 2.5 - 2.6.

Standard fluid temperatures: -10÷+60°C. For other temperatures see pgs. 1.12 to 1.15.

Type of construction: Fan in Fe360 plate, impeller in Fe360 statically and dynamically balanced. For other materials see pgs. 1.12 to 1.15.

Operating specifications: Condition of inlet air T=20°C, 0 m above sea level and ρ=1.205 kg/m³.

Noise level: Expressed as sound power L_{wA} [dB(A)] measured in free field with ducted fan, see pgs. 1.43 to 1.49.

Orientations: No.8 RD (clockwise viewed from transmission side) and No.8 LG. Fan in bolted orientable version for sizes 500-630, with front support and so not orientable for sizes 710 and above with transmission drive, always orientable for directly coupled fans without front support. See pg. 2.7.

Special applications: See pgs. 2.20 to 2.30.

Fan start-up: The VC series fans must be started-up with inlet completely closed. Check the electrical motor manufacturer's data for the effective number of start-ups per hour that the motor is able to sustain; unless otherwise indicated take one start-up per hour to be the maximum.

If it is necessary to start up the fan more frequently and this can be achieved by installing a larger motor.

During start-up the peak current can reach as much as 7 times the nominal current and the electrical components should be scaled appropriately.

Impeller classes: The above table refers to standard operating conditions, in heavy-duty service conditions it is advisable to contact the MORO Customer Service to establish the most suitable type of impeller.

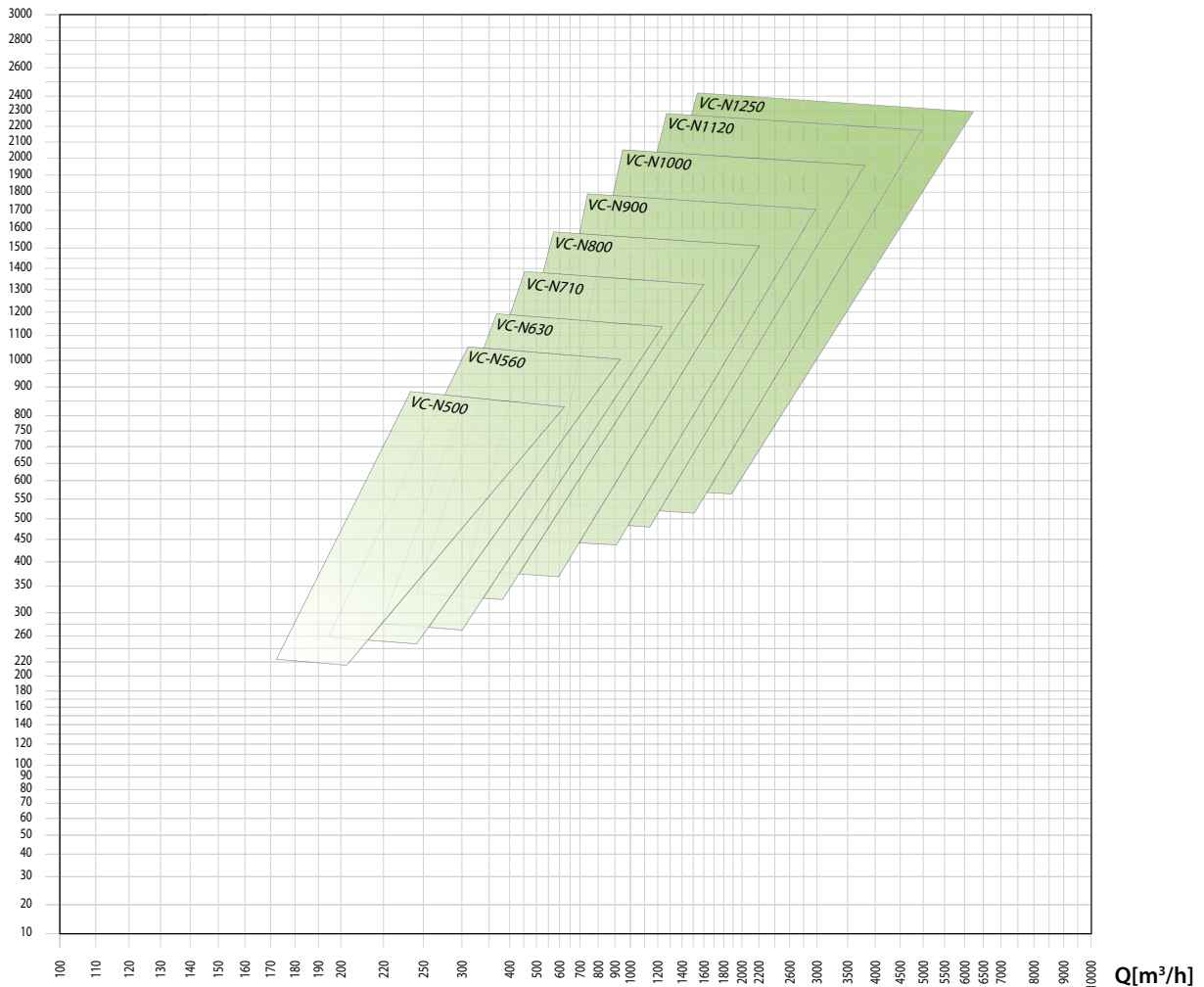
pt [mmH₂O]

■ **Arbeitsbereich:** Mittlere - niedrige Fördermengen. Hohe Drücke.

Schaufelform: Kurve, rückwärts gekrümmt (negativ), siehe Seite 2.2.

Anwendungen: Zum Transport von Stäuben, zur Trocknung und für mit Überdruck zu beaufschlagende Räume. Zur Verwendung im industriellen Bereich, Giessereien, Nudelfabriken, Öfen und der Chemie geeignet.

Konstruktive Standardausführungen: Ausf. 1-Ausf. 4-Ausf. 5-Ausf. 8-Ausf. 9-Ausf. 12, siehe Seiten 2.5 - 2.6.

Standardtemperatur des Mediums: -10 ÷ +60°C. Für andere Temperaturen siehe Seiten 1.12 bis 1.15.

Konstruktionsart: Ventilator aus Blech Fe360, Laufrad aus Fe360, statisch und dynamisch ausgewuchtet. Für andere Materialien siehe Seiten 1.12 bis 1.15.

Betriebsdaten: Physikalischer Zustand der Ansaugluft T = 20°C, 0 m ü. M. und $\rho = 1.205 \text{ kg/m}^3$.

Geräuschpegel: Angegeben als Schalleistungspegel L_{wA} [dB(A)] mit Messung im Freifeld und an Rohren angeschlossenem Ventilatore, siehe Seiten 1.43 bis 1.49.

Ausrichtung: 8 Modelle RD (Drehrichtung im Uhrzeigersinn, von Antriebsseite aus gesehen) und 8 Modelle LG. Angeschraubter, in der Ausrichtung veränderbarer Ventilator in den Grössen 500-630, mit Vorderstütze und damit nicht veränderbar ab Grösse 710 mit Riementrieb, immer ausrichtbar bei allen direkt angetriebenen Ventilatoren ohne Vorderstütze, siehe Seite 2.7.

Spezialausführungen: Siehe Seiten 2.20 bis 2.30.

Ventilator-Anlauf: Für die Ventilatoren der Reihe VC muss unbedingt ein Anlauf mit vollständig geschlossener Ansaugseite sichergestellt sein.

Mit den Angaben des Herstellers des Elektromotors die Anzahl der zulässigen Anläufe pro Stunde überprüfen; falls nicht anders angegeben, ist von einem Anlauf pro Stunde auszugehen.

Falls häufigere Anläufe vorzusehen sind, kann ein stärkerer Elektromotor eingebaut werden.

Während des Anlaufs kann der Anlaufstrom bis zum Siebenfachen des Nennstroms betragen, der elektrische Anschluss ist in geeigneter Weise auszuliegen.

Laufradklassen: Die obestehende Tabelle bezieht sich auf normale Betriebsbedingungen. Bei erschwerenden Betriebsbedingungen wird empfohlen, den Kundenservice der MORO zu kontaktieren, um den am besten geeigneten Laufradtyp zu bestimmen.

■ **Campo de trabajo:** Caudales medio-bajos. Presiones altas.

Tipo de pala: Curva, invertida (negativa), ver pág. 2.2.

Aplicaciones: Para transporte neumático, polvos, desecación y presurización. Apto para el uso en el campo industrial: fundiciones, fábricas de pasta, hornos e industria química.

Variantes constructivas estándares: Ejec.1-Ejec.4-Ejec.5-Ejec.8-Ejec.9-Ejec.12, ver págs. 2.5 - 2.6.

Temperaturas del fluido estándares: De -10 a +60°C. Para otras temperaturas, ver págs. de 1.12 a 1.15.

Tipo de construcción: Ventilador de chapa en Fe360, rotor en Fe360 equilibrado estática y dinámicamente. Para otros materiales, ver págs. de 1.12 a 1.15.

Datos de funcionamiento: Condiciones del aire en aspiración T=20°C, 0 m SNM y $\rho = 1.205 \text{ kg/m}^3$.

Niveles de ruido: Expresados en potencia sonora L_{wA} [dB(A)] medida en campo abierto con ventilador canalizado, ver págs. de 1.43 a 1.49.

Orientaciones: 8 RD (rotación dextrógira vista desde el lado de transmisión) y 8 LG. Ventilador en versión emperrada orientable para tamaños 500-630, con soporte delantero, por lo cual no es orientable a partir del tamaño 710 en ventiladores acoplados directamente sin soporte delantero. Ver pág. 2.7.

Construcciones especiales: Ver págs. de 2.20 a 2.30.

Puesta en marcha del ventilador: Los ventiladores de la serie VC deben necesariamente encenderse con la aspiración completamente cerrada.

Comprobar a partir de los datos del fabricante del motor eléctrico el número efectivo de encendidos/hora que el motor puede soportar. Considerar un máximo de un encendido/hora, de no indicarse lo contrario.

En caso de que se plantee la necesidad de encender el ventilador con mayor frecuencia, la instalación de un motor de mayor tamaño puede evitar el problema. Durante el encendido, la corriente de arranque puede llegar a ser 7 veces la corriente nominal, por lo tanto, el tamaño y la capacidad de los componentes eléctricos deberán calcularse de acuerdo con ello.

Clases de rotores: La tabla arriba hace referencia a condiciones de trabajo estándares, en condiciones de funcionamiento pesadas, se aconseja llamar al Servicio de atención al cliente de MORO para conocer el tipo de rotor más adecuado.

Tipo • Type • Type • Typ • Tipo		P inst. [kW]	n	LpA [dB(A)]	Tolleranza sulla portata ±5% • Tolérance sur le débit ±5% • Load tolerance ±5% • Durchsatztoleranz ±5% • Tolerancia respecto caudal ±5%										
Ventilatore • Ventilateur • Fan • Ventilator • Ventilador	Motore • Moteur • Motor • Motor • Motor				Q [m³/h]										
					215	252	288	324	360	400	430	470	540	650	720
		pt[mmH ₂ O]													
VC500/N2R	80	1,1	2845	62	401	404	408	412	415	417	416	415	413	403	
VC500/N2	90	1,5	2845	63	433	437	440	444	447	450	451	452	450	444	438
VC560/N2R	90	1,5	2845	64		502	505	511	516	518	520	522	525		
VC560/N2	90	2,2	2890	66			556	563	568	572	574	577	579	583	584
VC630/N2R	100	3	2900	67			644	649	651	656	658	662	667	673	675
VC630/N2R	112	4	2900	67			644	649	651	656	658	662	667	673	675
VC630/N2	112	4	2900	68				730	734	739	741	746	752	759	764
VC630/N2	132	5,5	2925	68				742	746	751	753	758	764	771	776
VC710/N2R	132	5,5	2925	70					872	877	880	884	889	896	902
VC710/N2R	132	7,5	2930	70					873	878	881	885	890	897	903
VC710/N2	132	7,5	2930	71						976	980	984	991	1000	1005
VC710/N2	160	11	2940	71						983	987	991	998	1007	1012
VC800/N2R	132	7,5	2930	72							1088	1095	1102	1110	1117
VC800/N2R	160	11	2940	72							1095	1102	1109	1117	1124
VC800/N2	160	11	2940	73								1244	1251	1262	1266
VC800/N2	160	15	2950	73								1252	1259	1270	1274
VC900/N2R	160	15	2950	76									1417	1425	1430
VC900/N2R	160	18,5	2950	76									1417	1425	1430
VC900/N2	160	18,5	2950	78										1586	1595
VC900/N2	180	22	2960	78										1596	1605
VC1000/N2R	200	30	2960	79											
VC1000/N2R	200	37	2960	79											
VC1000/N2	200	37	2960	81											
VC1000/N2	225	45	2970	81											
VC1120/N2R	225	45	2970	82											
VC1120/N2R	250	55	2980	82											
VC1120/N2	250	55	2980	83											
VC1120/N2	280	75	2980	83											

CARATTERISTICHE IN ASPIRAZIONE

Tipo • Type • Type • Typ • Tipo		P inst. [kW]	n	LpA [dB(A)]	Tolleranza sulla portata ±5% • Tolérance sur le débit ±5% • Load tolerance ±5% • Durchsatztoleranz ±5% • Tolerancia respecto caudal ±5%										
Ventilatore • Ventilateur • Fan • Ventilator • Ventilador	Motore • Moteur • Motor • Motor • Motor				Q [m³/h]										
					215	252	288	324	360	400	430	470	540	650	720
		pt[mmH ₂ O]													
VC500/N2R	80	1,1	2845	62	384	385	388	391	392	392	390	387	382	366	
VC500/N2	90	1,5	2845	63	413	416	418	420	422	423	423	422	416	404	393
VC560/N2R	90	1,5	2845	64		477	479	483	487	488	489	489	490		
VC560/N2	90	2,2	2890	66			525	530	534	537	538	539	539	538	536
VC630/N2R	100	3	2900	67			604	608	610	614	615	618	620	623	623
VC630/N2R	112	4	2900	67			604	608	610	614	615	618	620	623	623
VC630/N2	112	4	2900	68				680	683	686	688	691	695	698	701
VC630/N2	132	5,5	2925	68				690	693	697	698	702	705	709	711
VC710/N2R	132	5,5	2925	70					802	806	809	811	815	819	823
VC710/N2R	132	7,5	2930	70					803	807	809	812	816	820	824
VC710/N2	132	7,5	2930	71						890	893	896	901	906	909
VC710/N2	160	11	2940	71						896	899	901	906	912	915
VC800/N2R	132	7,5	2930	72							983	988	994	999	1004
VC800/N2R	160	11	2940	72							989	994	999	1005	1010
VC800/N2	160	11	2940	73								1109	1114	1122	1124
VC800/N2	160	15	2950	73								1115	1120	1128	1130
VC900/N2R	160	15	2950	76									1245	1250	1254
VC900/N2R	160	18,5	2950	76									1245	1250	1254
VC900/N2	160	18,5	2950	78										1373	1379
VC900/N2	180	22	2960	78										1381	1387
VC1000/N2R	200	30	2960	79											
VC1000/N2R	200	37	2960	79											
VC1000/N2	200	37	2960	81											
VC1000/N2	225	45	2970	81											
VC1120/N2R	225	45	2970	82											
VC1120/N2R	250	55	2980	82											
VC1120/N2	250	55	2980	83											
VC1120/N2	280	75	2980	83											

Il livello di pressione sonora ponderato A, LpA (cap.14), corrisponde al valore rilevato, nelle condizioni di prova, nel punto di massima rumorosità.

Tolleranza sulla rumorosità ±4dB(A)																	
• Tolérance sur le bruit ±4dB(A) • Noise tolerance ±4dB(A)																	
• Geräushtoleranz ±4dB(A) • Tolerancia respecto a ruido ±4dB(A)																	
Q [m³/h]																	
790	865	935	1080	1225	1370	1440	1620	1800	2160	2520	2880	3240	3600	4500	5400	6300	7200
pt[mmH ₂ O]																	
430																	
582	579																
676	675	674	665														
676	675	674	665	652	630												
766	769	771	769	765													
778	781	783	782	778	768	754	744										
907	910	913	917	915	913	910											
908	911	914	918	916	914	911	905	880									
1009	1014	1017	1024	1028	1030	1029	1025	1019									
1016	1021	1024	1031	1035	1037	1036	1032	1026	990	936							
1120	1125	1130	1140	1144													
1127	1132	1137	1147	1151	1156	1159	1161	1159	1147	1116							
1271	1274	1281	1293	1297	1302	1310	1314	1318									
1279	1282	1289	1301	1305	1310	1318	1322	1326	1325	1308	1295						
1433	1437	1443	1455	1465	1473	1476	1483	1493	1498								
1433	1437	1443	1455	1465	1473	1476	1483	1493	1498	1498	1493	1478					
1599	1605	1611	1616	1623	1635	1641	1652	1662	1673								
1609	1615	1621	1626	1633	1645	1651	1662	1672	1683	1693	1695	1688					
1780	1790	1795	1800	1810	1815	1820	1830	1845	1865	1875	1880	1890					
1780	1790	1795	1800	1810	1815	1820	1830	1845	1865	1875	1880	1890	1885	1860			
		1975	1985	1995	2005	2010	2020	2035	2040	2060	2075	2085	2095				
		1990	2000	2010	2020	2025	2035	2050	2055	2075	2090	2100	2110	2100	2070	1990	
			2230	2235	2240	2250	2260	2275	2295	2310	2325	2340	2350	2365			
			2245	2250	2255	2265	2275	2290	2310	2325	2340	2355	2365	2380	2375		
				2505	2510	2520	2525	2535	2555	2575	2590	2615	2625				
				2505	2510	2520	2525	2535	2555	2575	2590	2615	2625	2650	2660	2650	2630

CARATTERISTICHE IN ASPIRAZIONE

Tolleranza sulla rumorosità ±4dB(A)																	
• Tolérance sur le bruit ±4dB(A) • Noise tolerance ±4dB(A)																	
• Geräushtoleranz ±4dB(A) • Tolerancia respecto a ruido ±4dB(A)																	
Q [m³/h]																	
790	865	935	1080	1225	1370	1440	1620	1800	2160	2520	2880	3240	3600	4500	5400	6300	7200
pt[mmH ₂ O]																	
380																	
530	523																
622	618	615	600														
622	618	615	600	582	554												
700	701	700	692	682													
711	711	710	703	693	677	660	640										
826	827	828	827	821	815	809											
827	828	828	828	822	815	810	798	769									
911	914	915	917	916	913	910	899	886									
917	920	921	923	922	919	916	905	892	919	776							
1006	1009	1012	1018	1019													
1011	1015	1018	1024	1024	1026	1027	1024	1018	1043	959							
1127	1129	1133	1141	1142	1143	1148	1147	1146									
1134	1135	1140	1147	1148	1149	1154	1153	1152	1187	1115	1090						
1256	1258	1262	1270	1276	1281	1282	1285	1290	1317								
1256	1258	1262	1270	1276	1281	1282	1285	1290	1317	1280	1268	1246					
1382	1386	1390	1392	1396	1404	1407	1413	1418	1450								
1390	1393	1397	1400	1404	1411	1415	1421	1425	1457	1428	1421	1406					
1517	1524	1527	1530	1536	1539	1542	1548	1557	1587	1571	1570	1571					
1517	1524	1527	1530	1536	1539	1542	1548	1557	1587	1571	1570	1571	1562	1525			
		1656	1662	1669	1675	1678	1683	1692	1711	1702	1708	1710	1711				
		1667	1673	1679	1685	1688	1694	1703	1721	1713	1719	1720	1721	1697	1654	1570	
			1832	1835	1838	1845	1851	1860	1883	1879	1886	1893	1896	1895			
			1843	1845	1848	1855	1861	1870	1893	1889	1896	1903	1906	1905	1889		
				2014	2017	2023	2026	2031	2054	2053	2060	2073	2076				
				2014	2017	2023	2026	2031	2054	2053	2060	2073	2076	2082	2076	2055	2026

■ Le niveau de pression sonore pondérée A, LpA (chap. 14), correspond à la valeur relevée dans les conditions d'essai au point de niveau sonore maximum.

■ Der nach A bewertete Schalldruckpegel LpA (Kap. 14) entspricht in den Testbedingungen dem höchsten gemessenen Wert des Geräuschpegels.

■ The A-weighted sound power level, LpA (Chap.14), is the value measured in test conditions at the point of maximum noise level.

■ El nivel de presión sonora ponderado A, LpA (cap. 14), corresponde al valor medido, en las condiciones de prueba, en el punto con máximos niveles de ruido.

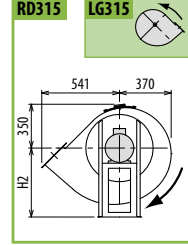
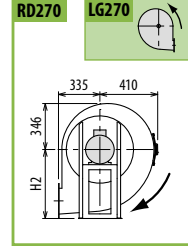
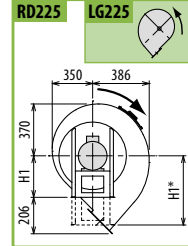
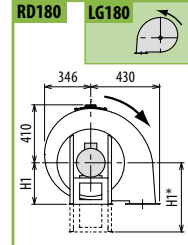
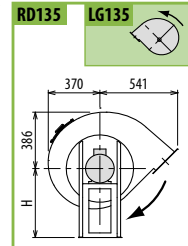
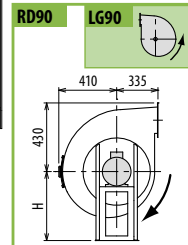
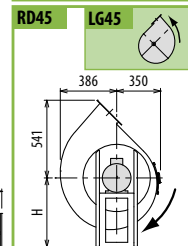
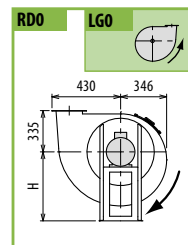
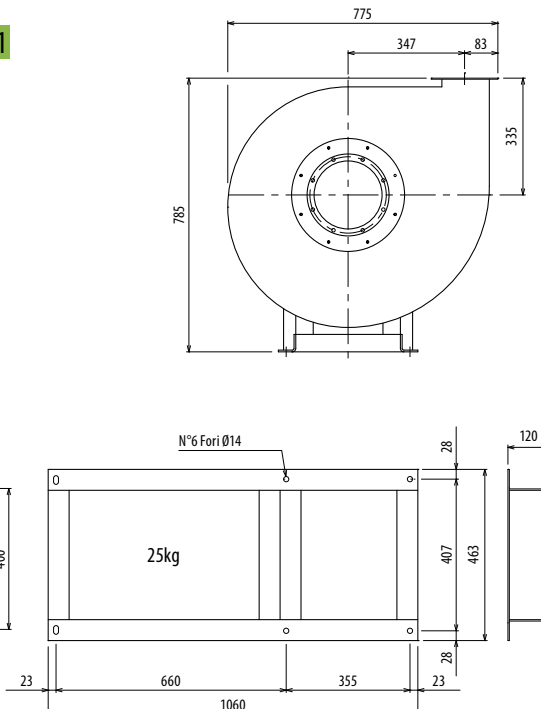
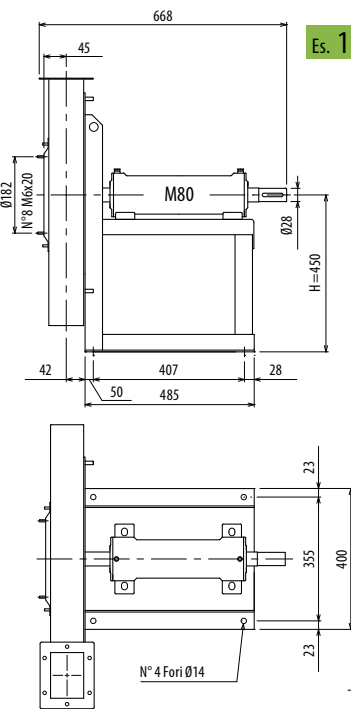
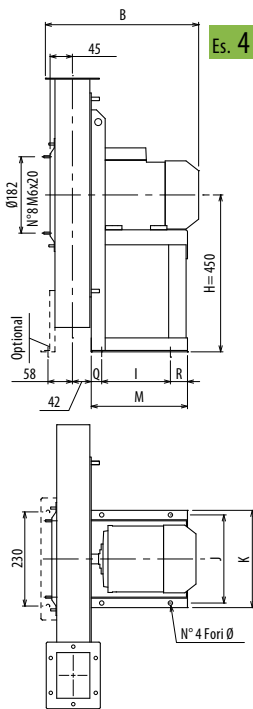

Il ventilatore è orientabile • Peso in tabella comprensivo di motore

- Le ventilateur est orientable
- The fan is revoluble
- Der Ventilator ist drehbar
- El ventilador es orientable
- Le poids dans le tableau inclut le moteur
- The weight indicated in the table includes motor
- Das Gewicht im Tafel schließt den Motor ein
- El peso en la tabla incluye el motor

Ulteriori informazioni e quote:
 ■ Ulérieures informations et cotes:
 ■ Further information and sizes:
 ■ Weitere Infos und Größen:
 ■ Más informaciones y medidas:

TIPO • Type		PESO Weight Kg	PD ² Kgf x m ²	B	I	H	H1	H2	J	K	M	Q	R	Ø
VENTILATORE Fan	MOTORE Motor													
VC500/N2R	80 B2	40	1,18	344	121	450	450*	450	203	225	211	45	45	10
VC500/N2	90 S2	43	1,2	391	133	450	450*	450	234	260	246	55	58	10
VC500/N/T		63	1,2			450	335	450						

pg. / s.
3,6

pg. / s.
3,5

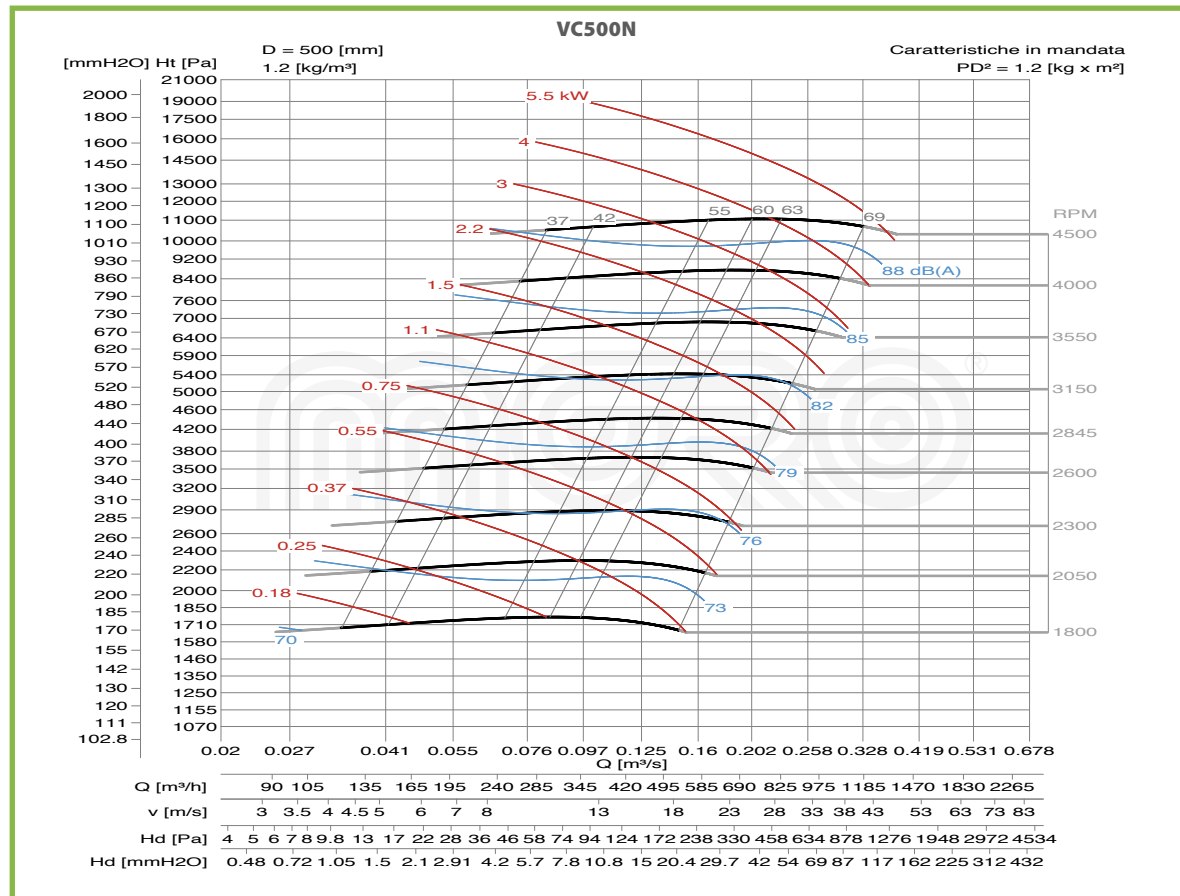
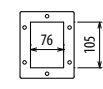
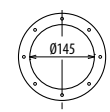

DIMENSIONI D'INGOMBRO E PESI/CURVE DI FUNZIONAMENTO

■ DIMENSIONS D'ENCOMBREMENT ET POIDS/COURBES DE FONCTIONNEMENT ■ OVERALL DIMENSIONS AND WEIGHT/WORKING CURVES
 ■ AUSMAßE UND GEWICHTE/FUNKTIONSKURVEN ■ DIMENSIONES QUE OCUPA Y PESOS/CURVAS DE FUNCIONAMIENTO

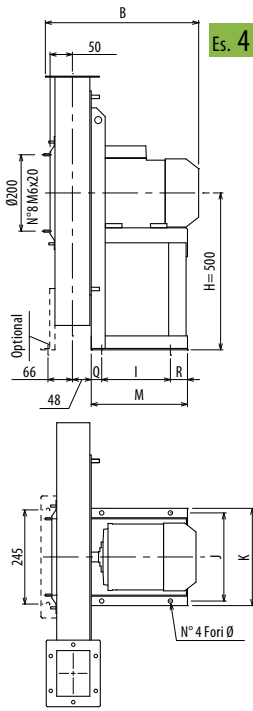

Es. 4

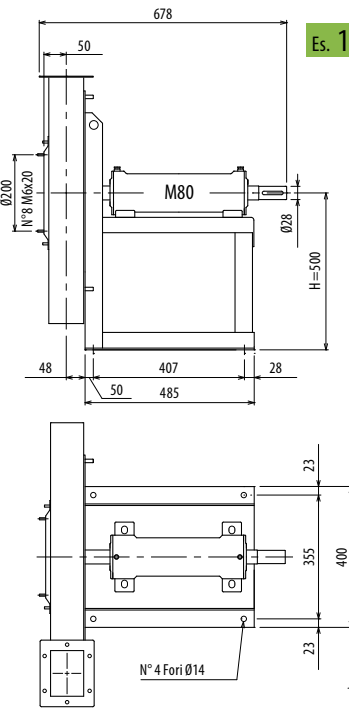

Es. 1

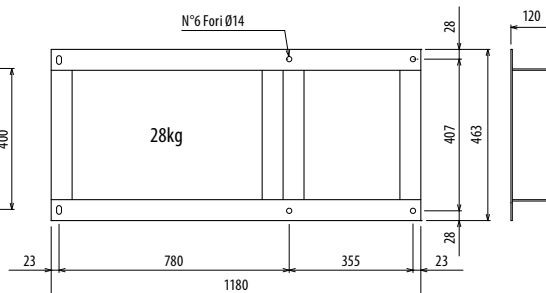
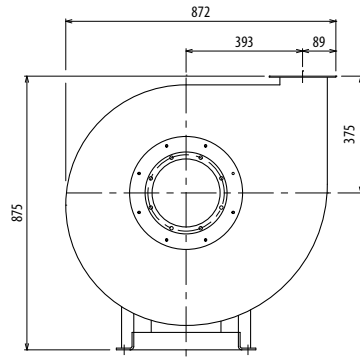

Il ventilatore è orientabile • Peso in tabella comprensivo di motore

- Le ventilateur est orientable
- The fan is revolvable
- Der Ventilator ist drehbar
- El ventilador es orientable
- Le poids dans le tableau inclut le moteur
- The weight indicated in the table includes motor
- Das Gewicht im Tafel schließt den Motor ein
- El peso en la tabla incluye el motor

Ulteriori informazioni e quote:
 ■ Ulérieures informations et cotes:
 ■ Further information and sizes:
 ■ Weitere Infos und Größen:
 ■ Más informaciones y medidas:

TIPO - Type		PESO Weight Kg	PD ² Kg f x m ²	DIMENSIONI										
VENTILATORE Fan	MOTORE Motor			B	I	H	H1	H2	J	K	M	Q	R	Ø
VC560/N2R	90 S2	66	1,7	401	133	500	500*	500	234	260	246	55	58	10
VC560/N2	90 L2	69	1,8	401	133	500	500*	500	234	260	246	55	58	10
VC560/N/T		79	1,8			500	375	500						

pg. / s.
3,6

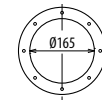

pg. / s.
3,5

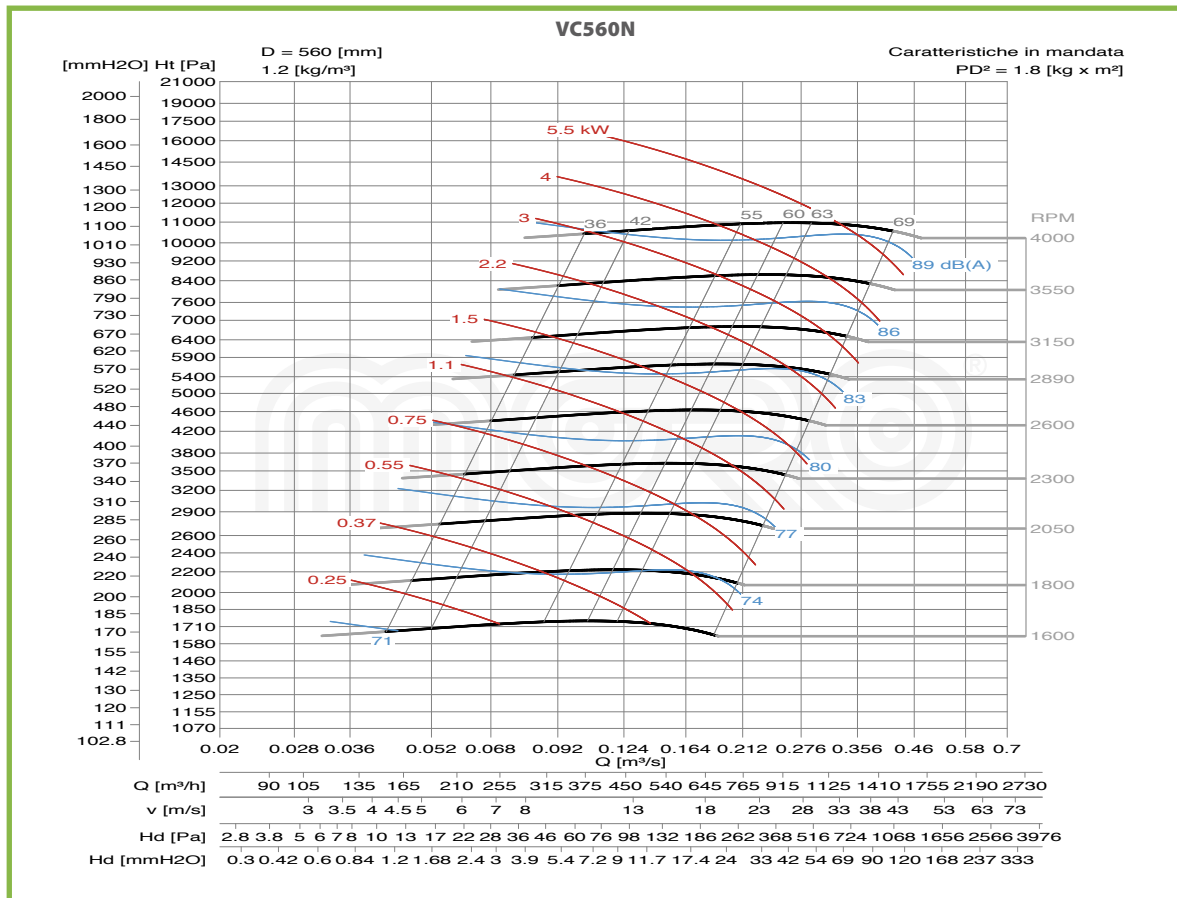
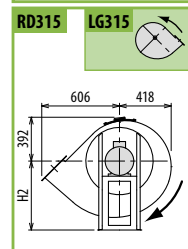
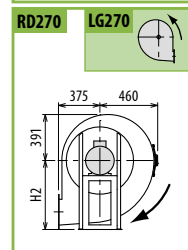
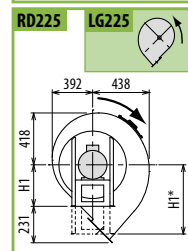
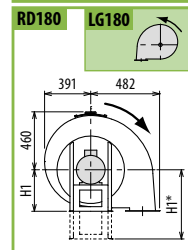
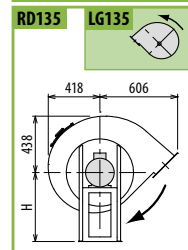
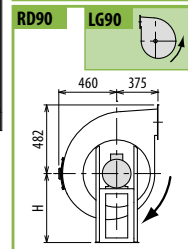
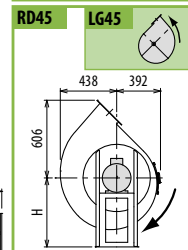
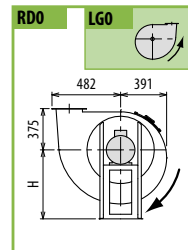

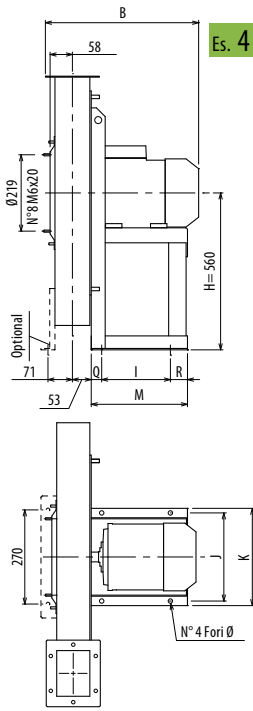
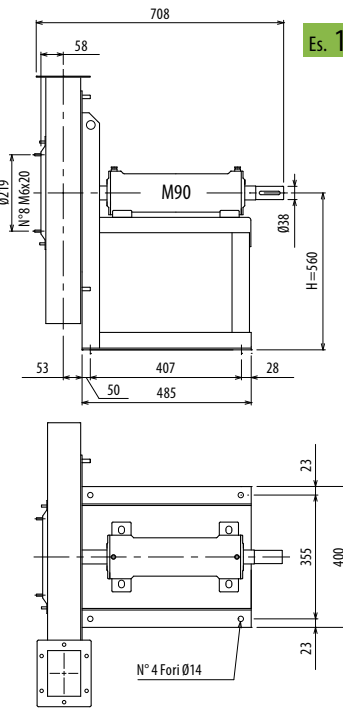
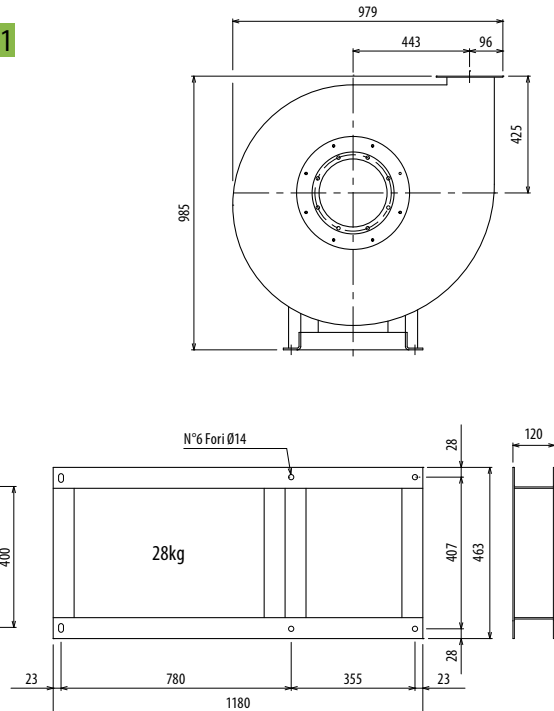
Es. 4

Es. 1

Il ventilatore è orientabile • Peso in tabella comprensivo di motore

- Le ventilateur est orientable
- The fan is revolvable
- Der Ventilator ist drehbar
- El ventilador es orientable
- Le poids dans le tableau inclut le moteur
- The weight indicated in the table includes motor
- Das Gewicht im Tafel schließt den Motor ein
- El peso en la tabla incluye el motor

 Ulteriori informazioni e quote:
 ■ Ulérieures informations et cotes:
 ■ Further information and sizes:
 ■ Weitere Infos und Größen:
 ■ Más informaciones y medidas:

TIPO • Type		PESO Weight Kg	PD ² Kgf x m ²	B	I	H	H1	H2	J	K	M	Q	R	Ø
VENTILATORE Fan	MOTORE Motor													
VC630/N2R	100 L2	118	2,4	442	197	560	560*	560	289	324	276	30	49	12
VC630/N2R	112 M2	132	2,4	463	197	560	560*	560	289	324	276	30	49	12
VC630/N2	112 M2	133	3,1	463	197	560	560*	560	289	324	276	30	49	12
VC630/N2	132 S2	143	3,1	503	237	560	560*	560	337	372	336	40	59	12
VC630/N/T		131	3,1			560	425	560						

pg. / s. 3,6

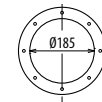

pg. / s. 3,5

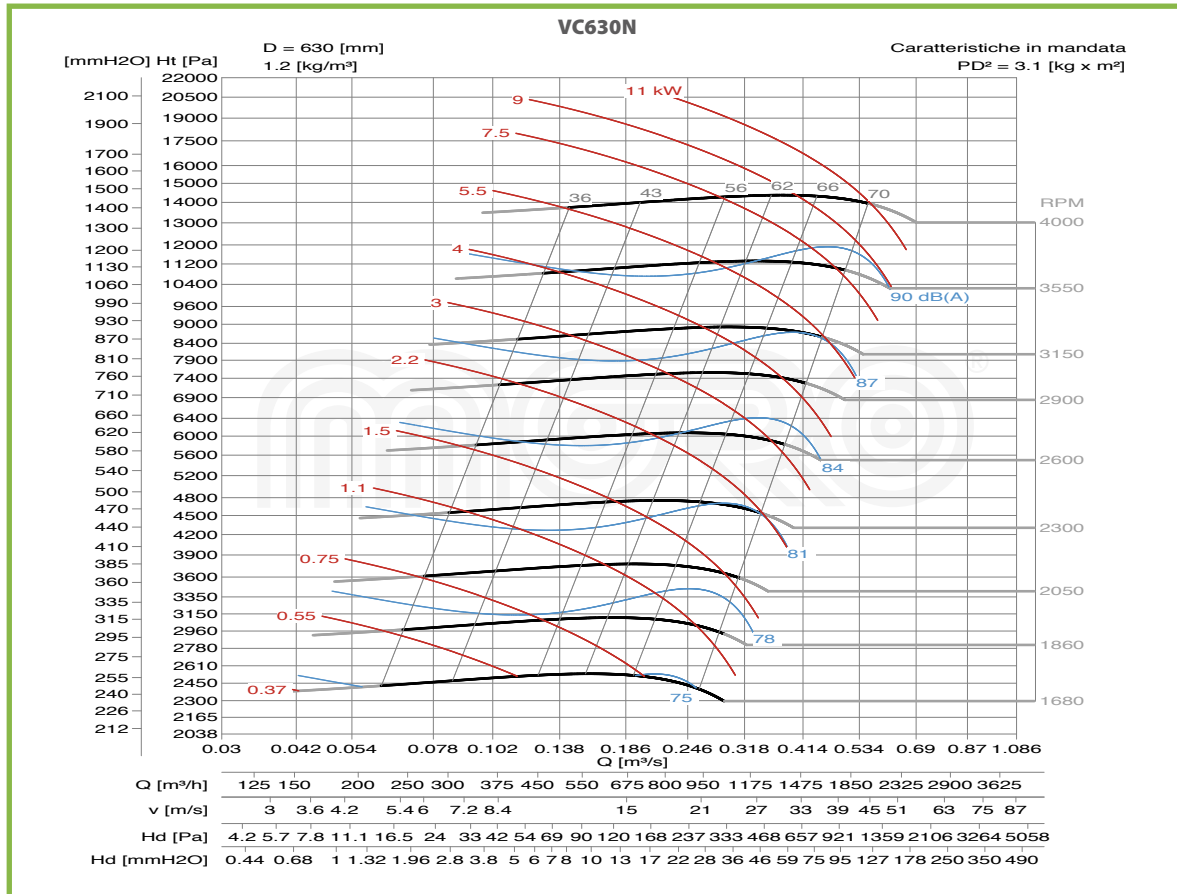
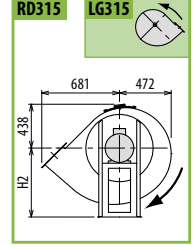
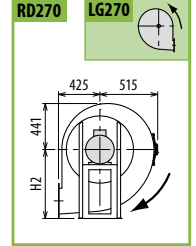
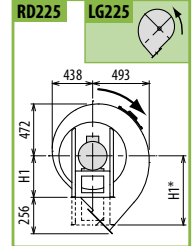
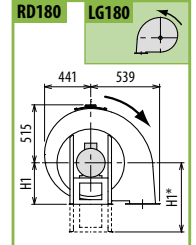
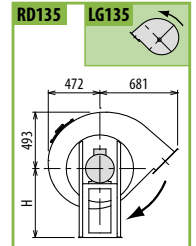
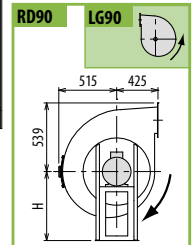
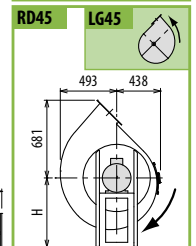
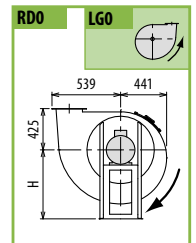

DIMENSIONI D'INGOMBRO E PESI/CURVE DI FUNZIONAMENTO

■ DIMENSIONS D'ENCOMBRE ET POIDS/COURBES DE FONCTIONNEMENT ■ OVERALL DIMENSIONS AND WEIGHT/WORKING CURVES
 ■ AUSMAßE UND GEWICHTE/FUNKTIONSKURVEN ■ DIMENSIONES QUE OCUPA Y PESOS/CURVAS DE FUNCIONAMIENTO

VC710/N



VC/N

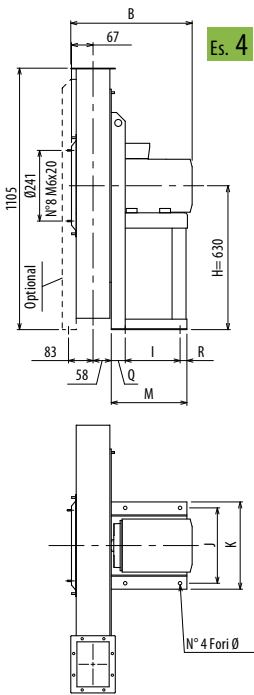

Es. 4

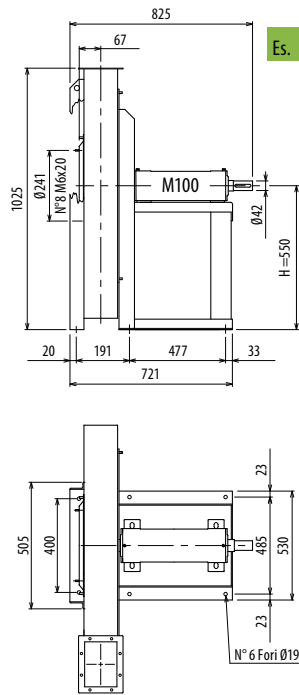

Es. 1

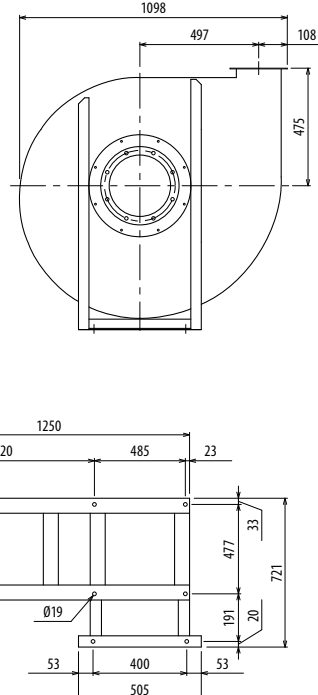

Il ventilatore in Es. 4 senza supporto anteriore è orientabile, in Es. 1 non è orientabile - Peso in tabella comprensivo di motore

■ Le ventilateur en Ex. 4 sans support frontal est orientable, en Ex. 1 n'est pas orientable.

■ The fan in Ex. 4 without front support is revolvable, in Ex. 1 is not revolvable.

Le poids dans le tableau inclut le moteur

The weight indicated in the table includes motor

■ Der Ventilator in Aus. 4, ohne Vorderhalterung, ist drehbar, in Aus. 1 ist nicht drehbar.

■ El ventilador en Ej. 4 sin soporte delantero es orientable, en Ej. 1 no es orientable.

Das Gewicht im Tafel schließt den Motor ein

El peso en la tabla incluye el motor

Ulteriori informazioni e quote:

■ Ulérieures informations et cotes:

■ Further information and sizes:

■ Weitere Infos und Größen:

■ Más informaciones y medidas:

TIPO - Type		PESO Weight Kg	PD ² Kgf x m ²	B	I	H	H1	H2	J	K	M	Q	R	Ø
VENTILATORE Fan	MOTORE Motor													
VC710/N2R	132 SA2	200	4,5	518	237	630*	630*	630	337	372	336	40	59	12
VC710/N2R	132 SB2	200	4,5	518	237	630*	630*	630	337	372	336	40	59	12
VC710/N2	132 SB2	204	6	518	237	630*	630*	630	337	372	336	40	59	12
VC710/N2	160 MA2	238	6	623	337	630*	630*	630	395	440	436	50	49	14
VC710/N/T		181	6			550	475	630						

pg. / s. 3,6



pg. / s. 3,5

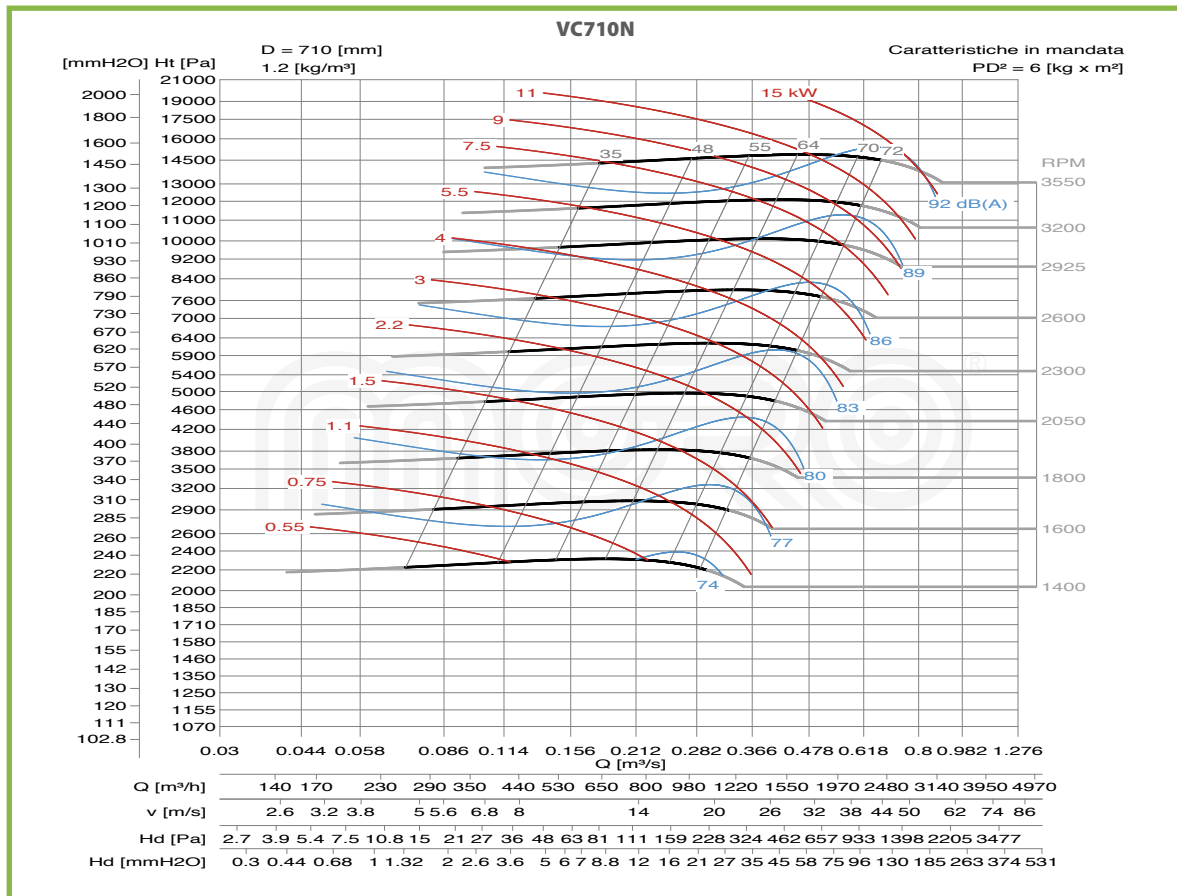

RD0 LG0

RD45 LG45

RD90 LG90

RD135 LG135

RD180 LG180

RD225 LG225

RD270 LG270

RD315 LG315

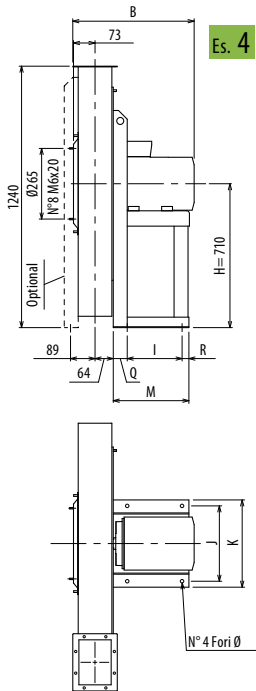

Es. 4

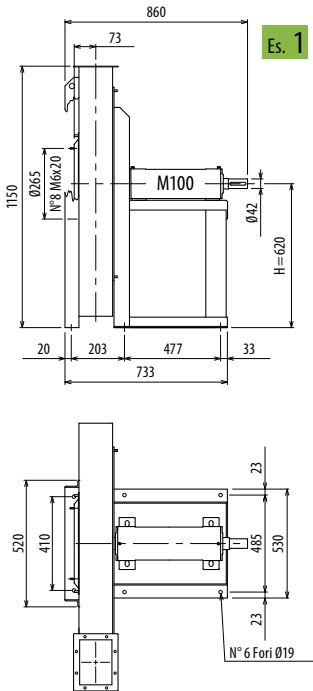

Es. 1

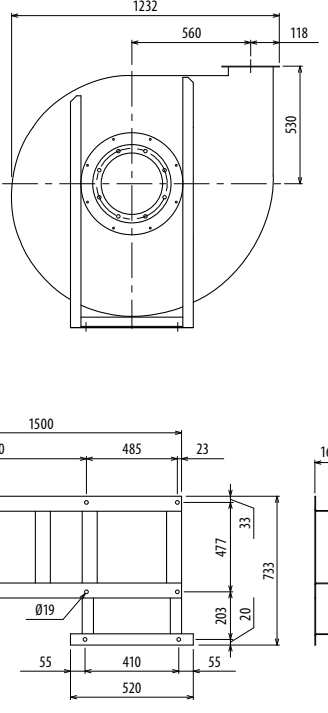

Il ventilatore in ES. 4 senza supporto anteriore è orientabile, in ES. 1 non è orientabile - Peso in tabella comprensivo di motore

- Le ventilateur en Ex. 4 sans support frontal est orientable, en Ex. 1 n'est pas orientable. ■ The fan in Ex. 4 without front support is revolvable, in Ex. 1 is not revolvable.
- Der Ventilator in Aus. 4, ohne Vorderhalterung, ist drehbar, in Aus. 1 ist nicht drehbar. ■ El ventilador in Ej. 4 sin soporte delantero es orientable, in Ej. 1 no es orientable.
- Das Gewicht in Tafel schließt den Motor ein. ■ El peso en la tabla incluye el motor

Ulteriori informazioni e quote:
 ■ Ulterérieures informations et cotes:
 ■ Further information and sizes:
 ■ Weitere Infos und Größen:
 ■ Más informaciones y medidas:

TIPO - Type		PESO Weight Kg	PD ² Kg f x m ²	B	I	H	H1	H2	J	K	M	Q	R	Ø
VENTILATORE Fan	MOTORE Motor													
VC800/N2R	132 SB2	214	8,5	530	237	710*	710*	710	337	372	336	40	59	12
VC800/N2R	160 MA2	248	8,5	635	337	710*	710*	710	395	440	436	50	49	14
VC800/N2	160 MA2	254	12	635	337	710*	710*	710	395	440	436	50	49	14
VC800/N2	160 MB2	254	12	635	337	710*	710*	710	395	440	436	50	49	14
VC800/N/T		199	12			620	530	710						

pg. / s. 3/6

pg. / s. 3/5

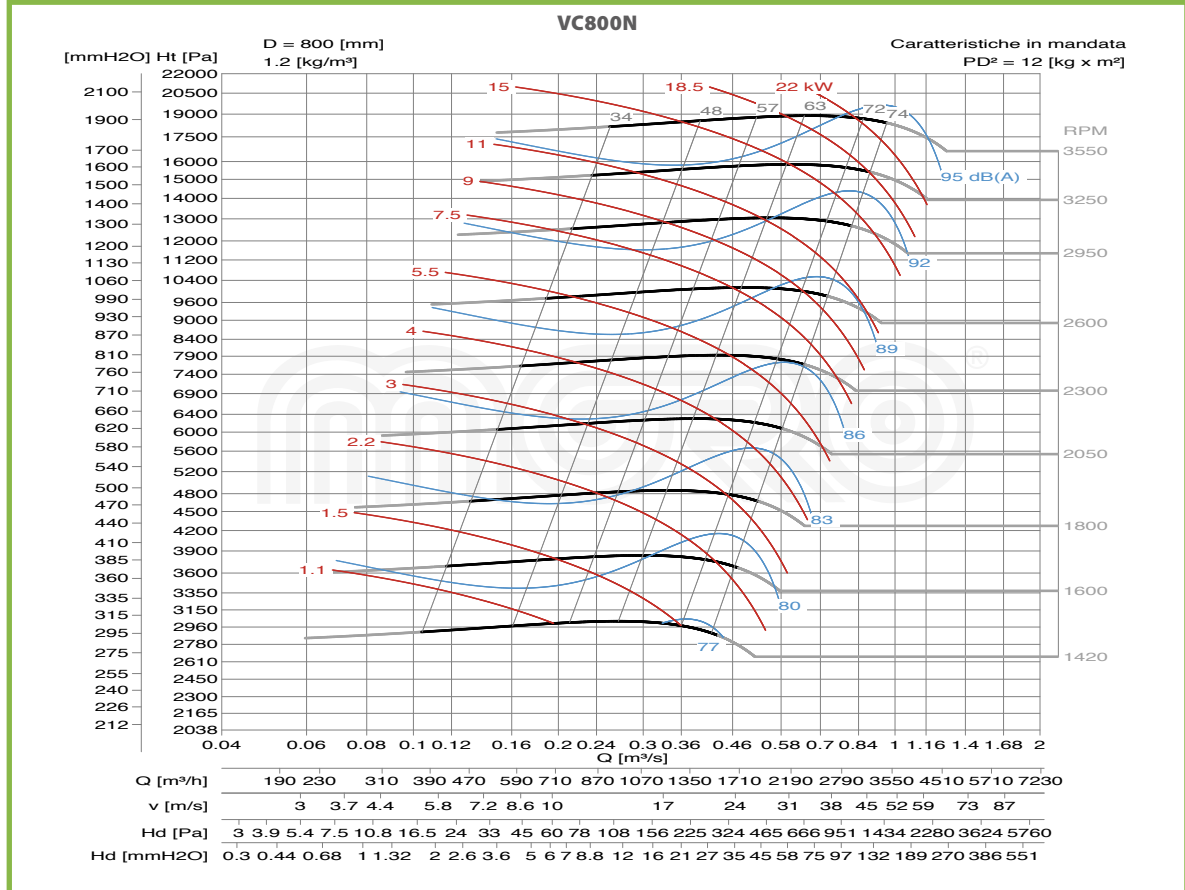
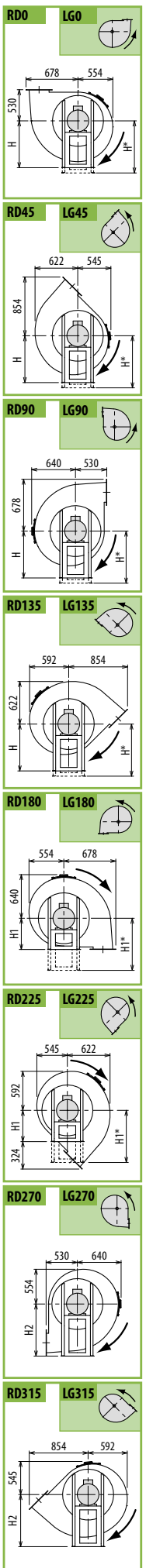

DIMENSIONI D'INGOMBRO E PESI/CURVE DI FUNZIONAMENTO

■ DIMENSIONS D'ENCOMBRE ET POIDS/COURBES DE FONCTIONNEMENT ■ OVERALL DIMENSIONS AND WEIGHT/WORKING CURVES
 ■ AUSMAß UND GEWICHTE/FUNKTIONSKURVEN ■ DIMENSIONES QUE OCUPA Y PESOS/CURVAS DE FUNCIONAMIENTO

VC900/N



VC/N

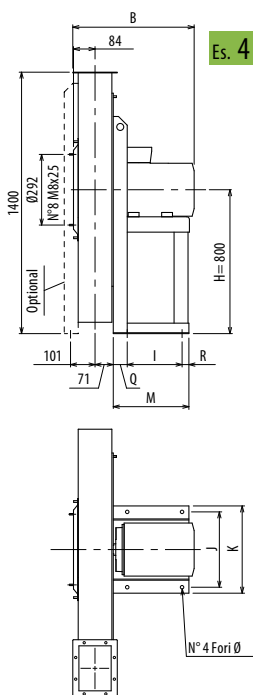

Es. 4

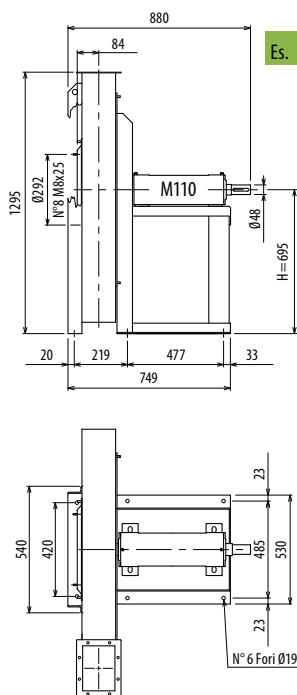

Es. 1

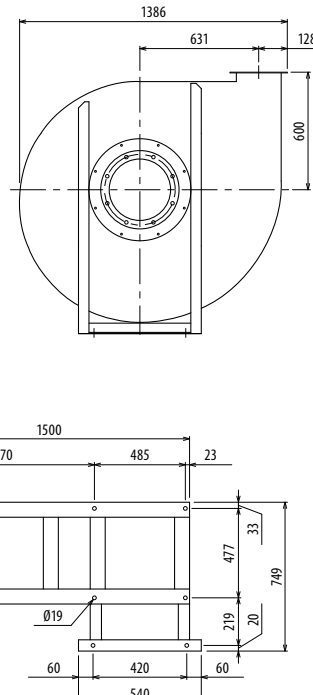

Il ventilatore in Es. 4 senza supporto anteriore è orientabile, in Es. 1 non è orientabile - Peso in tabella comprensivo di motore

- Le ventilateur en Ex. 4 sans support frontal est orientable, en Ex. 1 n'est pas orientable. ■ The fan in Ex. 4 without front support is revolvable, in Ex. 1 is not revolvable.
- Der Ventilator in Aus. 4, ohne Vorderhalterung, ist drehbar, in Aus. 1 ist nicht drehbar. ■ El ventilador en Ej. 4 sin soporte delantero es orientable, en Ej. 1 no es orientable.
- Das Gewicht im Tafel schließt den Motor ein ■ El peso en la tabla incluye el motor

Ulteriori informazioni e quote:
 ■ Ulérieures informations et cotes:
 ■ Further information and sizes:
 ■ Weitere Infos und Größen:
 ■ Más informaciones y medidas:

TIPO - Type		PESO Weight Kg	PD ² Kgf x m ²	B	I	H	H1	H2	J	K	M	Q	R	Ø
VENTILATORE Fan	MOTORE Motor													
VC900/N2R	160 MB2	333	14	649	337	800*	800*	800	395	440	436	50	49	14
VC900/N2R	160 L2	345	14	649	337	800*	800*	800	395	440	436	50	49	14
VC900/N2	160 L2	348	19	649	337	800*	800*	800	395	440	436	50	49	14
VC900/N2	180 M2	404	19	730	357	800*	800*	800	434	488	460	70	33	17
VC900/N/T		310	19			695	600	800						

pg. / s. 3,6



pg. / s. 3,5

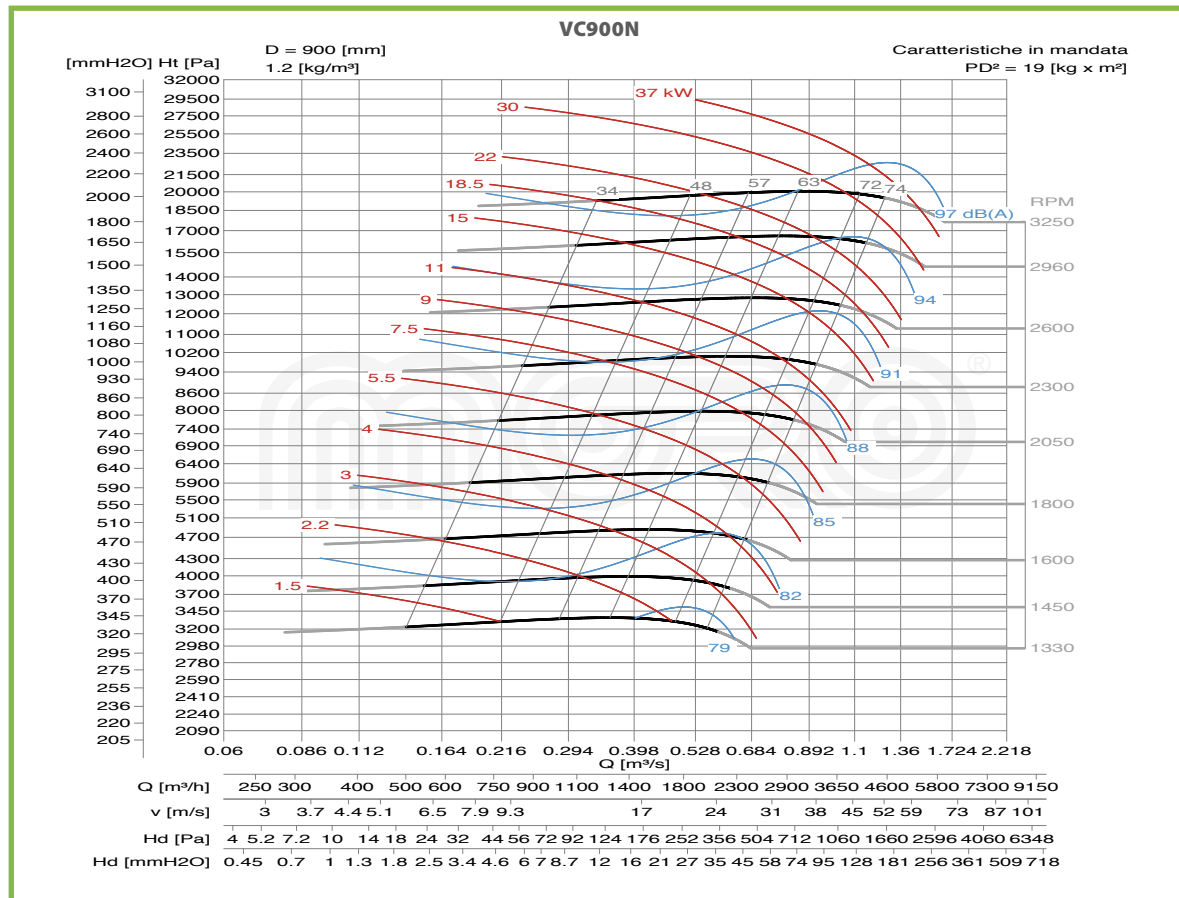
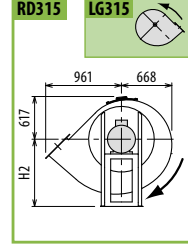
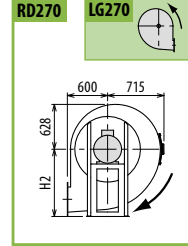
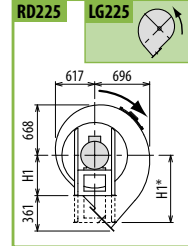
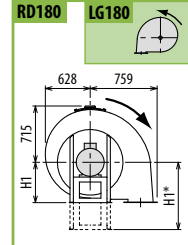
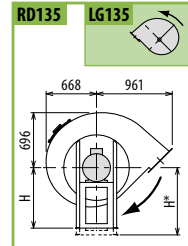
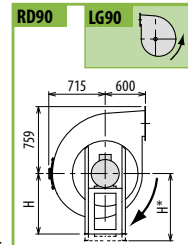
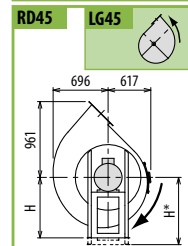
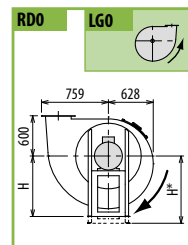

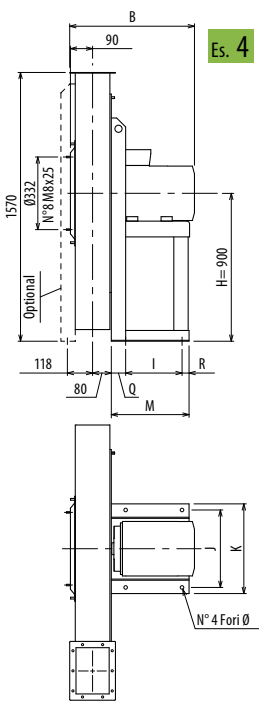
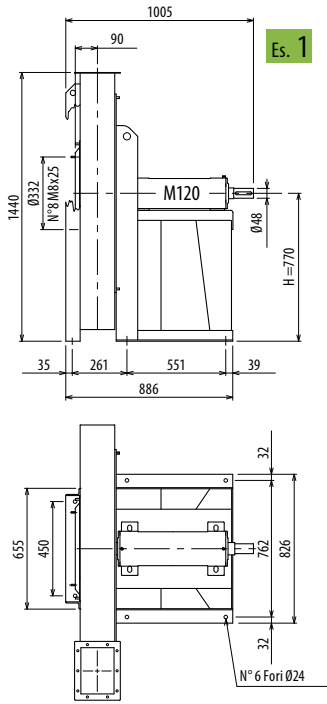
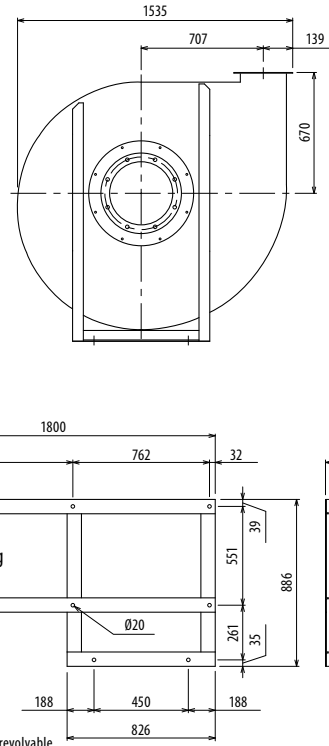
Es. 4

Es. 1

Il ventilatore in ES. 4 senza supporto anteriore è orientabile, in ES. 1 non è orientabile - Peso in tabella comprensivo di motore

■ Le ventilateur en Es. 4 sans support frontal est orientable, en Es. 1 n'est pas orientable.

■ The fan in Es. 4 without front support is revolvable, in Es. 1 is not revolvable.

Le poids dans le tableau inclut le moteur

The weight indicated in the table includes motor

■ Der Ventilator in Aus. 4, ohne Vorderhalterung, ist drehbar; in Aus. 1 ist nicht drehbar.

■ El ventilador en Ej. 4 sin soporte delantero es orientable, en Ej. 1 no es orientable.

Das Gewicht im Tafel schließt den Motor ein

El peso en la tabla incluye el motor

Ulteriori informazioni e quote:

■ Ulérieures informations et cotes:

■ Further information and sizes:

■ Weitere Infos und Größen:

■ Más informaciones y medidas:

TIPO - Type		PESO Weight Kg	PD ² Kgf x m ²	B	I	H	H1	H2	J	K	M	Q	R	Ø
VENTILATORE Fan	MOTORE Motor													
VC1000/N2R	200 LA2	570	25	856	381	900*	900*	900	506	568	500	80	39	19
VC1000/N2R	200 LB2	570	25	856	381	900*	900*	900	506	568	500	80	39	19
VC1000/N2	200 LB2	577	28	856	381	900*	900*	900	506	568	500	80	39	19
VC1000/N2	225 M2	657	28	898	421	900*	900*	900	556	616	540	80	39	19
VC1000/N/T		452	25			770	670	900						

pg./s. 3.6



pg./s. 3.5

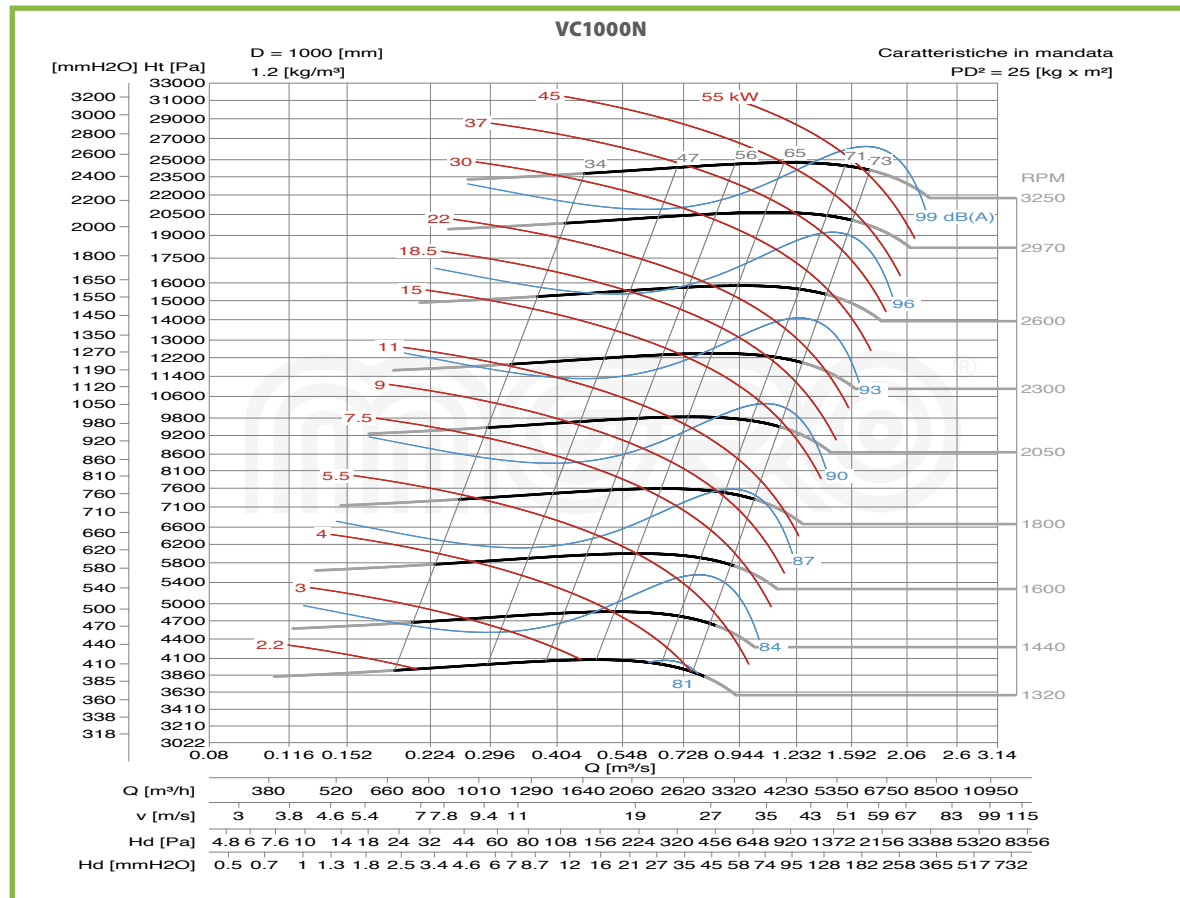
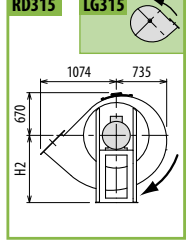
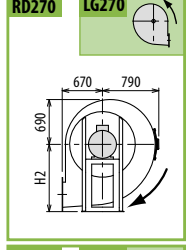
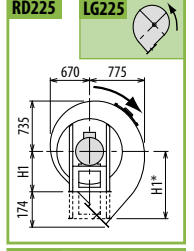
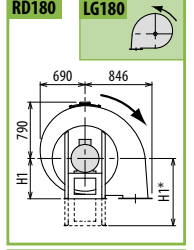
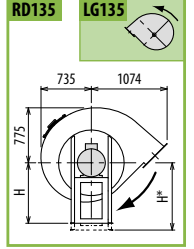
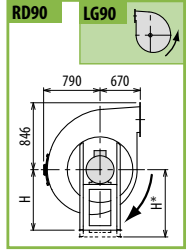
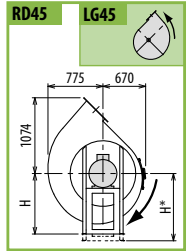
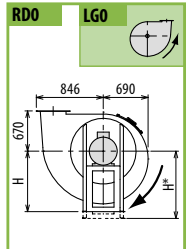

DIMENSIONI D'INGOMBRO E PESI/CURVE DI FUNZIONAMENTO

■ DIMENSIONS D'ENCOMBREMENT ET POIDS/COURBES DE FONCTIONNEMENT ■ OVERALL DIMENSIONS AND WEIGHT/WORKING CURVES
 ■ AUSMAß UND GEWICHT/FUNKTIONSKURVEN ■ DIMENSIONES QUE OCUPA Y PESOS/CURVAS DE FUNCIONAMIENTO

VC1120/N



VC/N

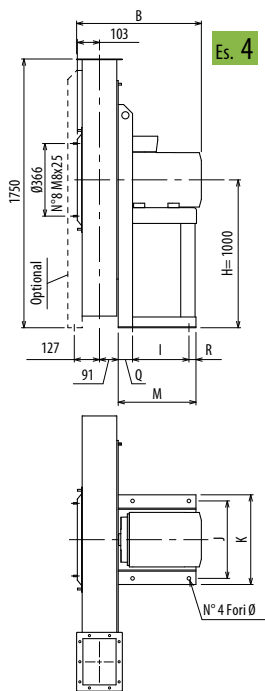

Es. 4

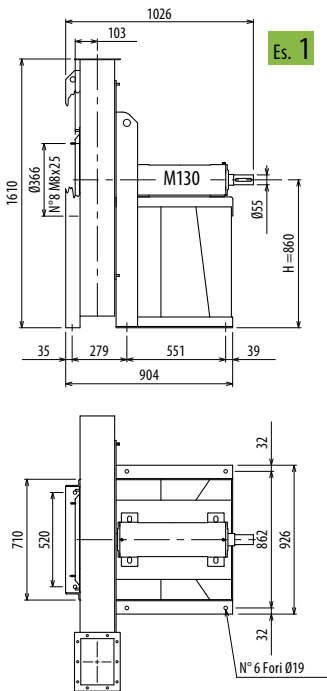

Es. 1

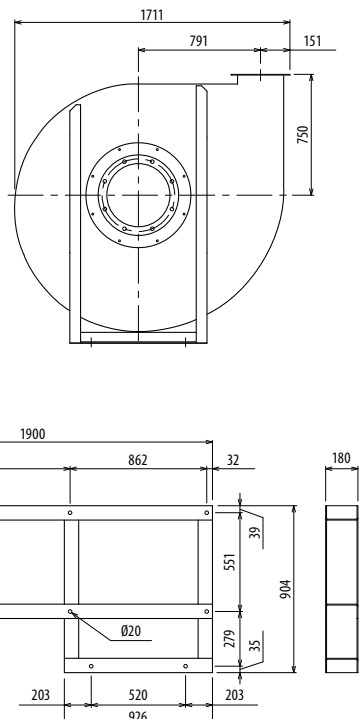

Il ventilatore in Es. 4 senza supporto anteriore è orientabile, in Es. 1 non è orientabile - Peso in tabella comprensivo di motore

- Le ventilateur en Ex. 4 sans support frontal est orientable, en Ex. 1 n'est pas orientable. ■ The fan in Ex. 4 without front support is revolvable, in Ex. 1 is not revolvable.
- Der Ventilator in Aus. 4, ohne Vorderhalterung, ist drehbar, in Aus. 1 ist nicht drehbar. ■ El ventilador en Ej. 4 sin soporte delantero es orientable, en Ej. 1 no es orientable.
- Das Gewicht im Tafel schließt den Motor ein. ■ El peso en la tabla incluye el motor

Ulteriori informazioni e quote:
 ■ Ulérieures informations et cotes:
 ■ Further information and sizes:
 ■ Weitere Infos und Größen:
 ■ Más informaciones y medidas:

TIPO - Type		PESO Weight Kg	PD ² Kgf x m ²	B	I	H	H1	H2	J	K	M	Q	R	Ø
VENTILATORE Fan	MOTORE Motor													
VC1120/N2R	225 M2	725	41	918	421	1000*	1000*	1000	556	616	540	80	39	19
VC1120/N2R	250 M2	815	41	1026	501	1000*	1000*	1000	604	690	600	60	39	19
VC1120/N2	250 M2	815	45	1026	501	1000*	1000*	1000	604	690	600	60	39	19
VC1120/N2	280 S2	945	45	1029	591	1000*	1000*	1000	690	750	697	60	46	21
VC1120/N/T		470	45			860	750	1000						

pg. / S. 3,6



pg. / S. 3,5



RD0 LG0

RD45 LG45

RD90 LG90

RD135 LG135

RD180 LG180

RD225 LG225

RD270 LG270

RD315 LG315

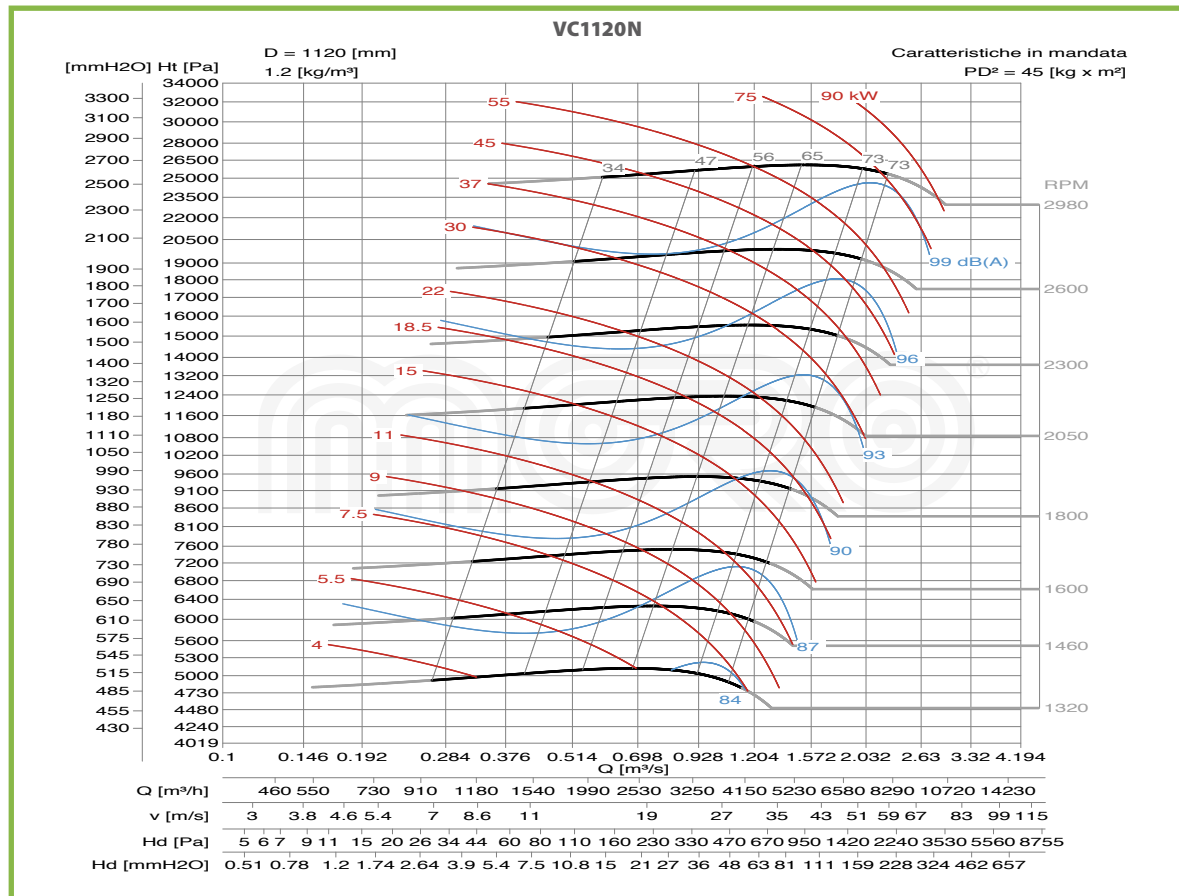

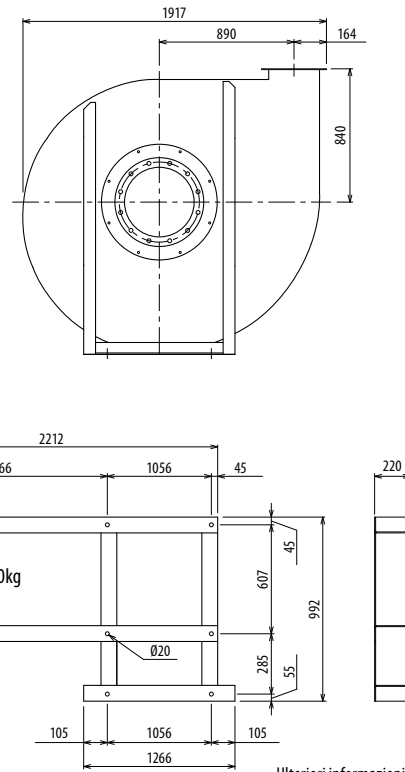
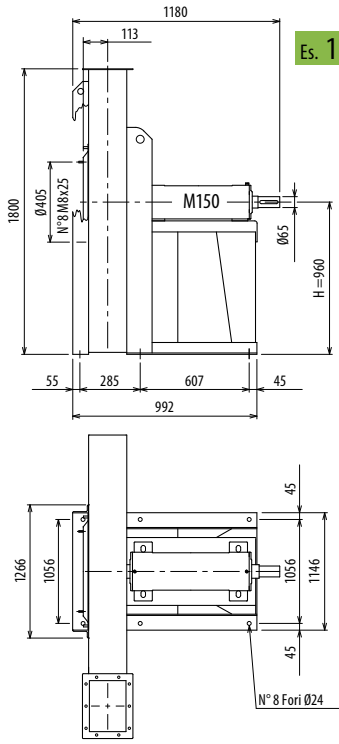

Il ventilatore non è orientabile

■ Le ventilateur n'est pas orientable

■ The fan is not revolvable

■ Der Ventilator ist nicht drehbar

■ El ventilador no es orientable

Ulteriori informazioni e quote:

■ Ulérieures informations et cotes:

■ Further information and sizes:

■ Weitere Infos und Größen:

■ Más informaciones y medidas:

TIPO - Type		PESO Weight Kg	PD ² Kgf x m ²	B	I	H	H1	H2	H3	H4	M
VENTILATORE Fan	MOTORE Motor										
VC1250/N/T		800	90			960	840	1120	960	1120	

pg. / s. 3.6

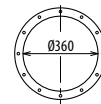

pg. / s. 3.5

