

Mod. **RL**

$Q = 1000 \div 270000 \text{ m}^3/\text{h}$

$Q = 0.3 \div 75 \text{ m}^3/\text{s}$

$p_t = 20 \div 460 \text{ mmH}_2\text{O}$

$p_t = 200 \div 4500 \text{ Pa}$

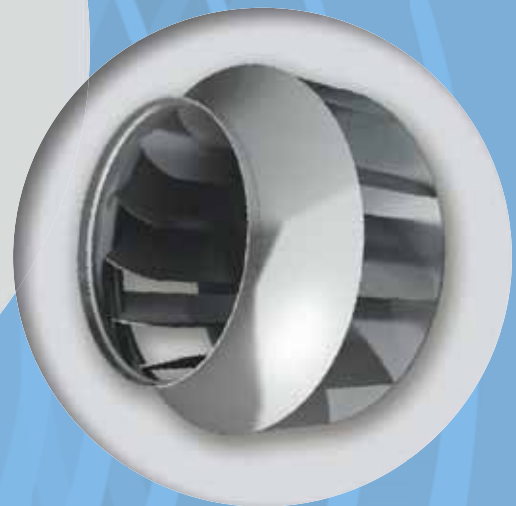
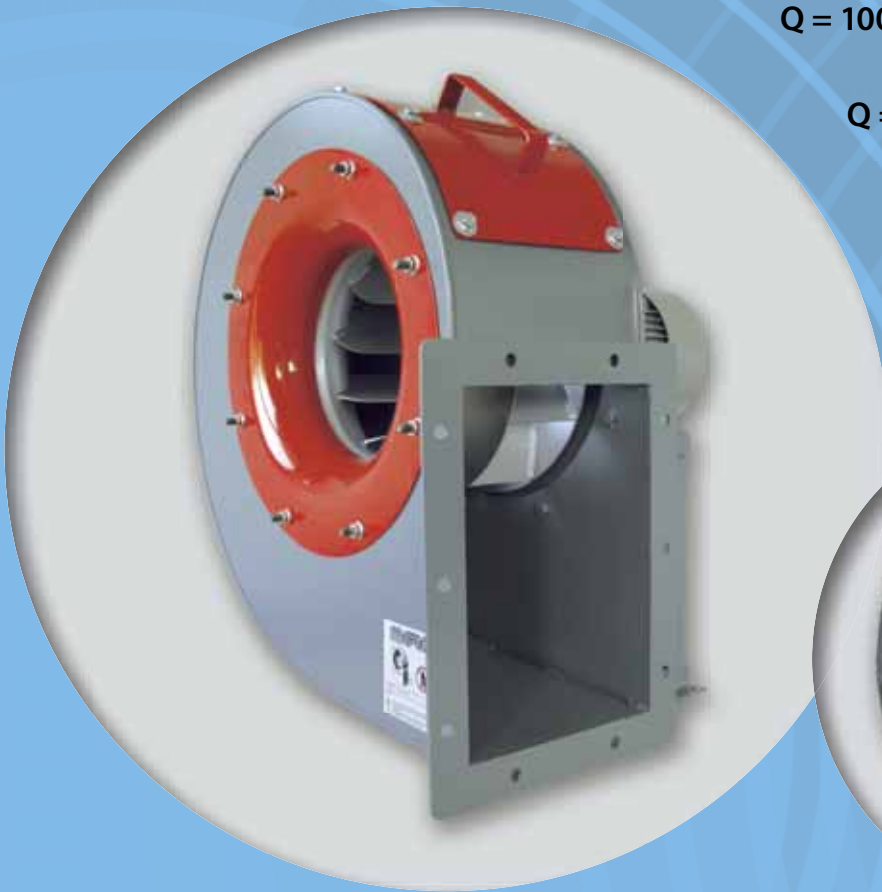

Campo di lavoro

Portate medie-alte. Pressioni basse.

Tipo di pala

Curva, rovescia (negativa), vedi pag. 2.2.

Applicazioni

Per aspirazione di aria pulita e leggermente polverosa, per applicazioni nell'impiantistica industriale e nel condizionamento civile e industriale.

Esecuzioni costruttive standard

Es.1-Es.4-Es.5-Es.8-Es.9-Es.12, vedi pag. 2.5 - 2.6.

Temperature del fluido standard

-10÷+60°C. Per altre temperature vedi da pag. 1.12 a pag. 1.15.

Tipo di costruzione

Ventilatore in lamiera di Fe360, girante in Fe360 equilibrata staticamente e dinamicamente. Per altri materiali vedi da pag. 1.12 a pag. 1.15.

Dati di funzionamento

 Condizioni dell'aria all'aspirazione T=20°C, 0m.s.l.m. e ρ=1.205 kg/m³.

Rumorosità

 Espresa in potenza sonora L_{wA} [dB(A)] rilevata in campo libero con ventilatore canalizzato, vedi da pag. 1.43 a pag. 1.49.

Orientamenti

N°8 RD (rotazione oraria vista lato trasmissione) e N°8 LG. Ventilatore in versione imbullonata orientabile per le taglie 250-630, orientamento fisso per le taglie 710-2000. Vedi pag. 2.7.

Costruzioni speciali

Vedi da pag. 2.20 a pag. 2.30.

Classi giranti

La seguente tabella fa riferimento a condizioni di lavoro standard. In condizioni di esercizio gravose si consiglia di contattare il servizio clienti di MORO per conoscere la tipologia di girante più idonea.

GRANDEZZA VENTILATORE • Grandeur • Size • Größe • Tamaño	RPM MASSIMO • Maxi tours/min. • Max rpm • Max. U/min • R.p.m. máx.		
	CLASSE I	CLASSE II	CLASSE III
RL250	4000	5000	6000
RL280	3800	4500	5300
RL310	3600	4100	4750
RL350	3250	3700	4250
RL400/R	2950	3300	3900
RL400	2950	3300	3900
RL450/R	2750	3150	3800
RL450	2550	2950	3550
RL500/R	2350	2750	3350
RL500	2250	2600	3150
RL560/R	2100	2450	3000
RL560	2000	2300	2850
RL630/R	1850	2150	2650
RL630	1750	2050	2500
RL710/R	1900	2300	2550
RL710	1800	2200	2400
RL800/R	1700	2050	2300
RL800	1600	1950	2150
RL900/R	1500	1850	2000
RL900	1450	1750	1900
RL1000/R	1350	1650	1800
RL1000	1250	1550	1700
RL1120/R	1250	1350	1450
RL1120	1200	1300	1400
RL1250/R	1150	1250	1350
RL1250	1100	1200	1300
RL1400/R	1050	1150	1250
RL1400	1000	1100	1200
RL1600	900	1000	1100
RL1800	800	900	1000
RL2000	700	800	900

VALORI VALIDI FINO A 60°C

 • Valeurs valables jusqu'à 60°C • Values valid up to 60°C
 • Werte bis 60°C gültig • Valores válidos hasta 60°C

FRA • entre • between • zwischen • entre	60°C	E • et • and • und • y	100°C	DECLASSARE VELOCITÀ • déclasser vitesse • degrade speed • Geschwindigkeit herabsetzen • rebajar velocidad	4%
			100°C		150°C
	150°C	200°C	16%		
	200°C	250°C	23%		
	250°C	300°C	30%		
	300°C	350°C	37%		
	350°C	400°C	45%		
	400°C	450°C	54%		
	450°C	500°C	64%		

■ Domaine de travail

Débits moyens-élevés Basses pressions.

Type d'ailette

Courbée, inversée (négative), voir page 2.2.

Applications

Pour aspiration d'air propre et légèrement poussiéreux, pour applications dans les installations industrielles et le conditionnement civil et industriel.

Configurations de constructions standard

Ex.1-Ex.4-Ex.5-Ex.8-Ex.9-Ex.12, voir pages 2.5 - 2.6.

Températures du fluide standard

-10÷+60°C. Pour d'autres températures voir pages 1.12-1.15.

Type de fabrication

Ventilateur en tôle de Fe360, turbine en Fe360 équilibrée statiquement et dynamiquement. Pour d'autres matériaux, voir pages 1.12-1.15.

Données de fonctionnement

 Conditions de l'air à l'aspiration T=20°C, 0 m asl et ρ=1.205 kg/m³.

Niveau sonore

 Exprimé en puissance sonore L_{wA} [dB(A)], relevé à l'air libre avec un ventilateur canalisé, voir pages 1.43 - 1.49.

Orientations

8 RD (rotation dans le sens des aiguilles d'une montre côté transmission) et 8 LG. Ventilateur en version boulonnée orientable pour les tailles 250-630, orientation fixe pour les tailles 710-2000. Voir page 2.7.

Fabrications spéciales

Voir pages 2.20-2.30.

Classes de turbines

Le tableau ci-dessus fait référence aux conditions de travail normales, en conditions de travail pénibles, on préconise de contacter le service clientèle de MORO pour connaître le type de turbine le plus adapté.

■ Field of operation

Medium-high flow rates. Low pressures.

Blade type

Curve, backward (negative), see pg. 2.2.

Applications

For the inlet of clean and slightly dusty air, for applications in industrial installations and civil and industrial air-conditioning systems.

Standard constructional arrangements

Arr.1-Arr.4-Arr.5-Arr.8-Arr.9-Arr.12, see pgs. 2.5 - 2.6.

Standard fluid temperatures

-10÷+60°C. For other temperatures see pgs. 1.12 to 1.15.

Type of construction

Fan in Fe360 plate, impeller in Fe360 statically and dynamically balanced. For other materials see pgs. 1.12 to 1.15.

Operating specifications

 Condition of inlet air T=20°C, 0 m above sea level and ρ=1.205 kg/m³.

Noise level

 Expressed as sound power L_{wA} [dB(A)] measured in free field with ducted fan, see pgs. 1.43 to 1.49.

Orientations

No.8 RD (clockwise viewed from transmission side) and No.8 LG. Fan in bolted orientable version for sizes 250-630, fixed orientation for sizes 710-2000. See pg. 2.7.

Special applications

See pgs. 2.20 to 2.30.

Impeller classes

The above table refers to standard operating conditions, in heavy-duty service conditions it is advisable to contact the MORO Customer Service to establish the most suitable type of impeller.

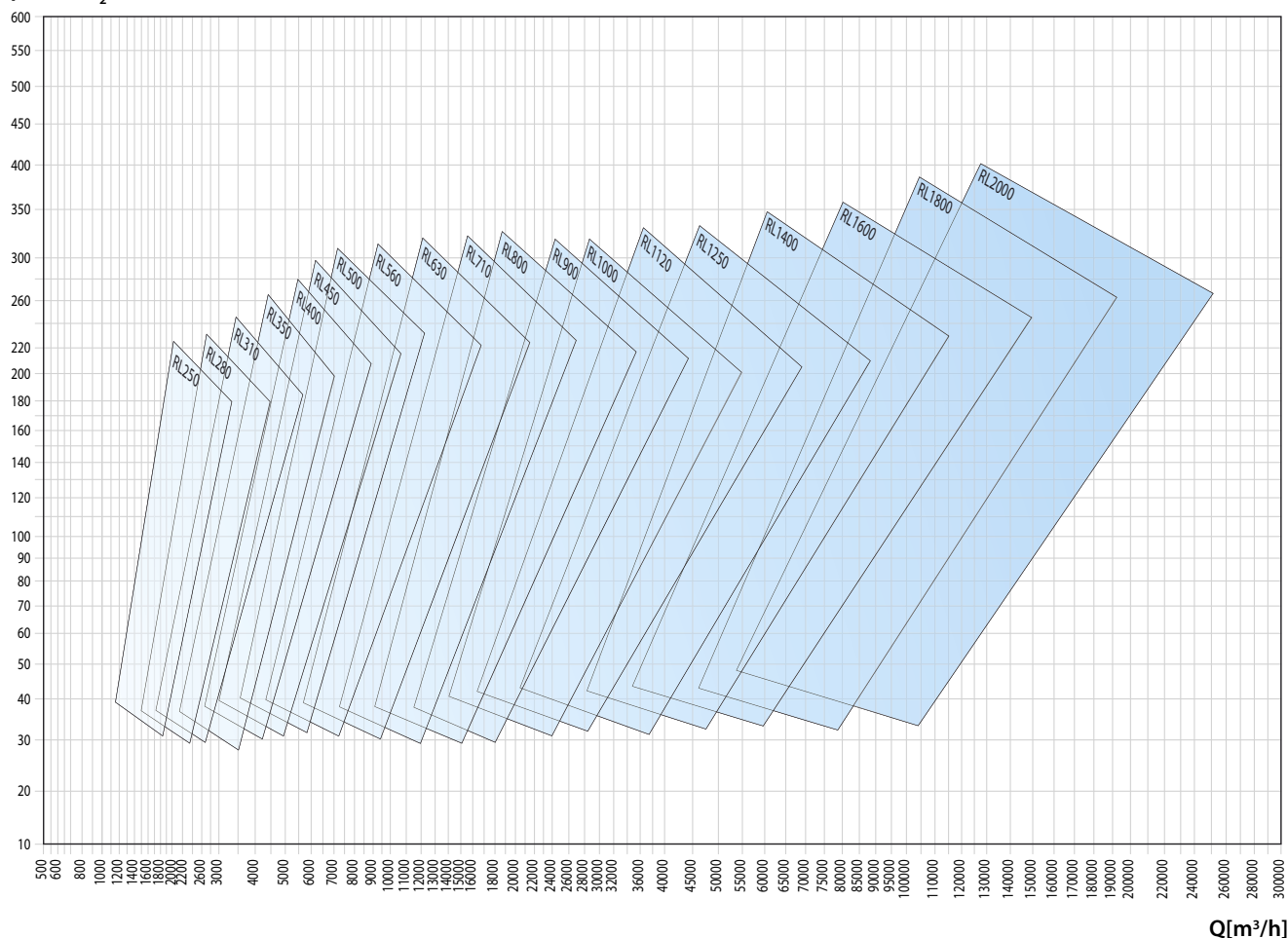
pt [mmH₂O]

■ Arbeitsbereich

Mittlere - grosse Fördermengen. Niedrige Drücke.

Schaufelform

Kurve, rückwärts gekrümmt (negativ), siehe Seite 2.2.

Anwendungen

Zur Absaugung von sauberer Luft, auch mit geringem Anteil von Sägestaub, für Anwendungen in Industrieanlagen und zur Klimatisierung in Häusern und Industrie.

Konstruktive Standardausführungen

Ausf. 1-Ausf. 4-Ausf. 5-Ausf. 8-Ausf. 9-Ausf. 12, siehe Seiten 2.5 - 2.6.

Standardtemperatur des Mediums

-10 ÷ +60°C. Für andere Temperaturen siehe Seiten 1.12 bis 1.15.

Konstruktionsart

Ventilator aus Blech Fe360, Laufrad aus Fe360, statisch und dynamisch ausgewuchtet. Für andere Materialien siehe Seiten 1.12 bis 1.15.

Betriebsdaten

Physikalischer Zustand der Ansaugluft T = 20°C, 0 m ü. M. und ρ = 1.205 kg/m³.

Geräuschpegel

angegeben als Schalleistungspegel L_{wA} [dB(A)] mit Messung im Freifeld und an Rohren angeschlossenem Ventilatore, siehe Seiten 1.43 bis 1.49.

Ausrichtung

8 Modelle RD (Drehrichtung im Uhrzeigersinn, von Antriebsseite aus gesehen) und 8 Modelle LG. Angeschraubter, in der Ausrichtung veränderbarer Ventilator in den Grössen 250 - 630, mit Vorderstütze und damit nicht veränderbar ab Grösse 710 mit Riementrieb, immer ausrichtbar bei allen direkt angetriebenen Ventilatoren ohne Vorderstütze, siehe Seite 2.7.

Spezialausführungen

Siehe Seiten 2.20 bis 2.30.

Laufradklassen

Die obenstehende Tabelle bezieht sich auf normale Betriebsbedingungen. Bei erschwerenden Betriebsbedingungen wird empfohlen, den Kundenservice der MORO zu kontaktieren, um den am besten geeigneten Laufradtyp zu bestimmen.

■ Campo de trabajo

Caudales medio-altos. Presiones bajas.

Tipo de pala

Curva, invertida (negativa), ver pág. 2.2.

Aplicaciones

Para aspiración de aire limpio y con ligera carga de polvo, para aplicaciones en instalaciones industriales y en acondicionamiento civil e industrial.

Variantes constructivas estándares

Ejec.1-Ejec.4-Ejec.5-Ejec.8-Ejec.9-Ejec.12, ver págs. 2.5 - 2.6.

Temperaturas del fluido estándares

De -10 a +60°C. Para otras temperaturas, ver págs. de 1.12 a 1.15.

Tipo de construcción

Ventilador de chapa en Fe360, rotor en Fe360 equilibrado estática y dinámicamente. Para otros materiales, ver págs. de 1.12 a 1.15.

Datos de funcionamiento

Condiciones del aire en aspiración T = 20°C, 0 m SNM y ρ = 1.205 kg/m³.

Niveles de ruido

Expresados en potencia sonora L_{wA} [dB(A)] medida en campo abierto con ventilador canalizado, ver págs. de 1.43 a 1.49.

Orientaciones

8 RD (rotación dextrógira vista desde el lado de transmisión) y 8 LG. Ventilador en versión emperrada orientable para tamaños 250-630, orientación fija para tamaños 710-2000. Ver pág. 2.7.

Construcciones especiales

Ver págs. de 2.20 a 2.30.

Clases de rotores

La tabla arriba hace referencia a condiciones de trabajo estándares, en condiciones de funcionamiento pesadas se aconseja llamar al Servicio de atención al cliente de MORO para conocer el tipo de rotor más adecuado.

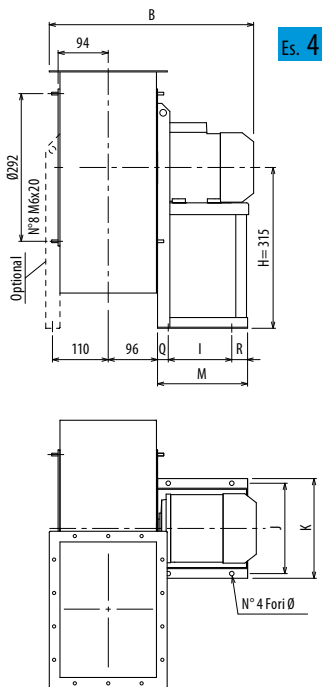

Es. 4

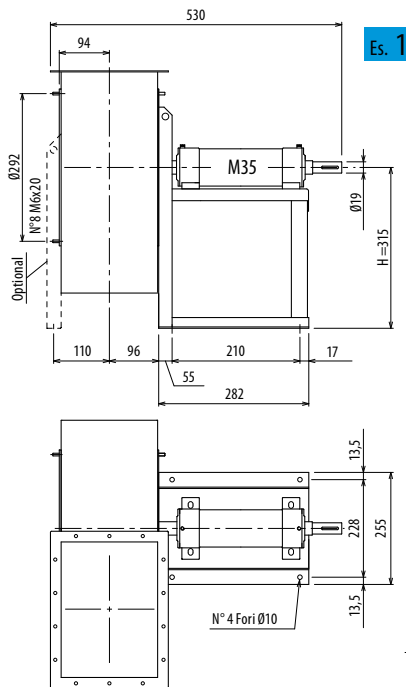

Es. 1

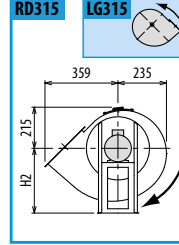
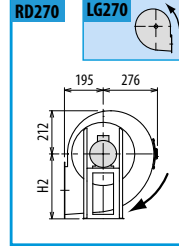
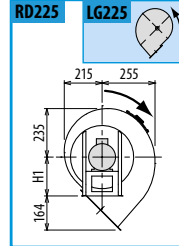
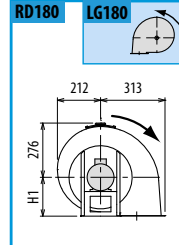
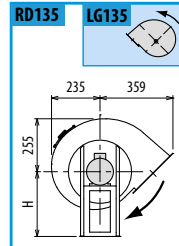
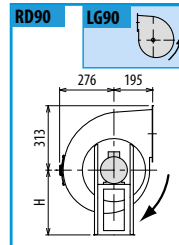
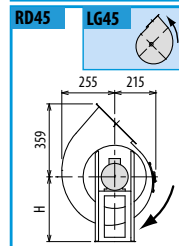
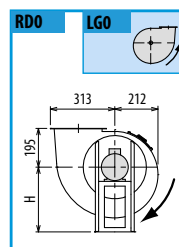
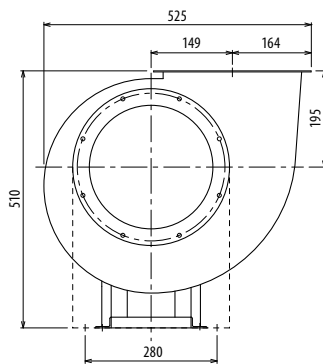

Il ventilatore è orientabile - Peso in tabella comprensivo di motore

- Le ventilateur est orientable
 - The fan is revolvable
 - Der Ventilator ist drehbar
 - El ventilador es orientable
- Le poids dans le tableau inclut le moteur The weight indicated in the table includes motor Das Gewicht im Tafel schließt den Motor ein El peso en la tabla incluye el motor

Ulteriori informazioni e quote:
 ■ Ulérieures informations et cotes:
 ■ Further information and sizes:
 ■ Weitere Infos und Größen:
 ■ Más informaciones y medidas:

TIPO - Type		PESO Weight	PD ²	B	I	H	H1	H2	J	K	M	Q	R	Ø
VENTILATORE Fan	MOTORE Motor	Kg	Kgf x m ²											
RL250/2	71 B2	37	0,11	434	121	315	195	315	203	225	196	49	26	10
RL250/T		32	0,14			315	195	315						

pg. / s. 3,6

pg. / s. 3,5

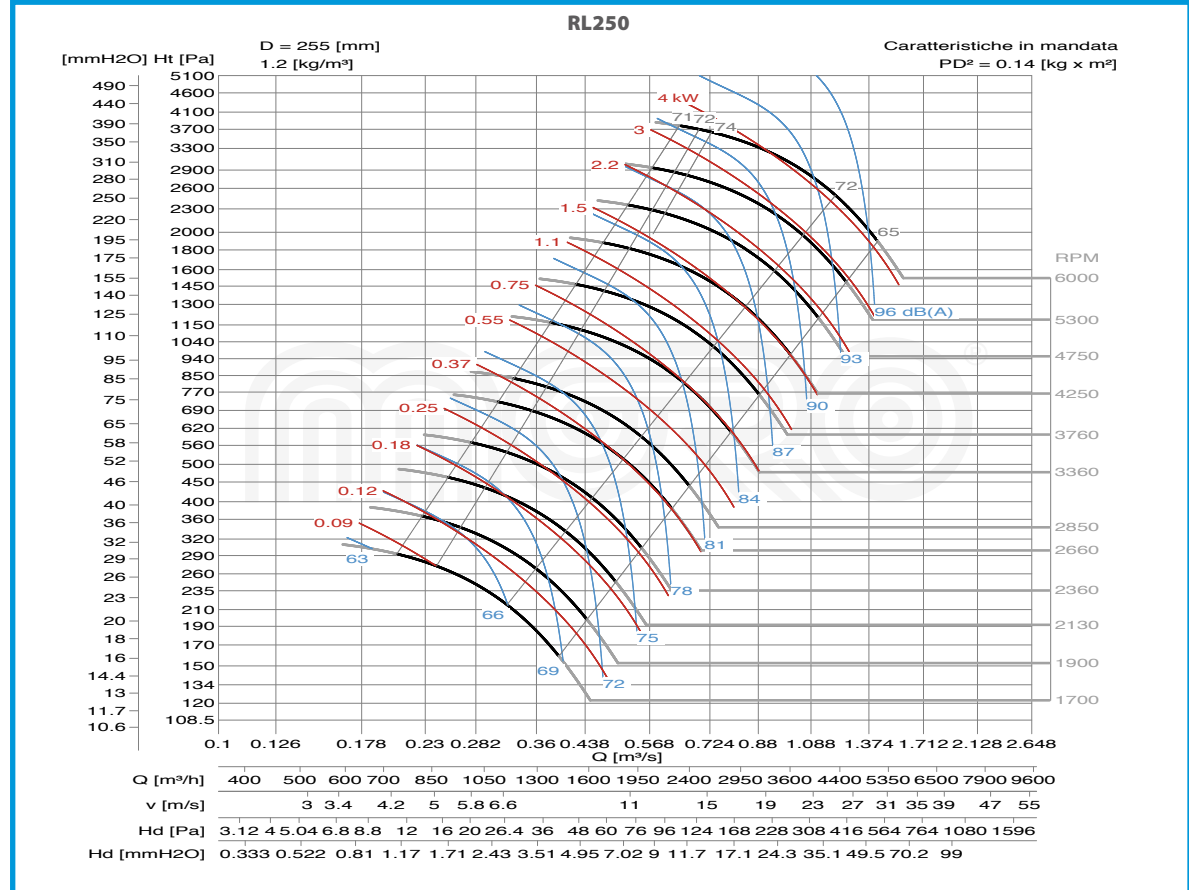
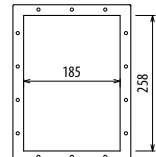
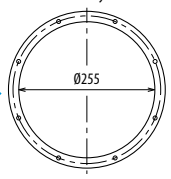

■ DIMENSIONS D'ENCREMBRE ET POIDS/COURBES DE FONCTIONNEMENT ■ OVERALL DIMENSIONS AND WEIGHT/WORKING CURVES
 ■ AUSMAßE UND GEWICHTE/FUNKTIONSKURVEN ■ DIMENSIONES QUE OCUPA Y PESOS/CURVAS DE FUNCIONAMIENTO

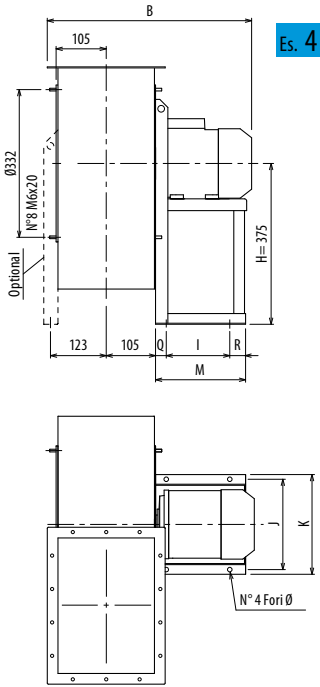

Es. 4

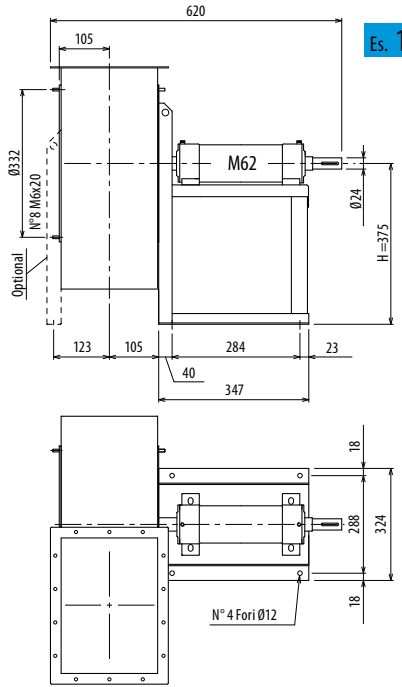

Es. 1

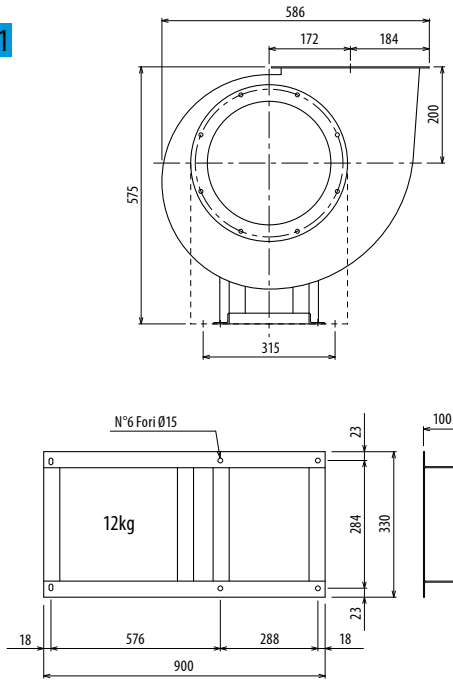

Il ventilatore è orientabile - Peso in tabella comprensivo di motore

- Le ventilateur est orientable
 - The fan is revolvable
 - Der Ventilator ist drehbar
 - El ventilador es orientable
- Le poids dans le tableau inclut le moteur The weight indicated in the table includes motor Das Gewicht im Tafel schließt den Motor ein El peso en la tabla incluye el motor

Ulteriori informazioni e quote:
 ■ Ulérieures informations et cotes:
 ■ Further information and sizes:
 ■ Weitere Infos und Größen:
 ■ Más informaciones y medidas:

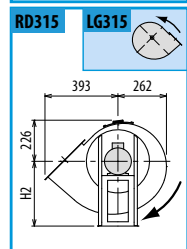
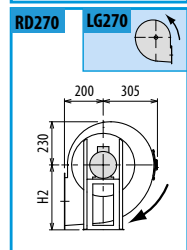
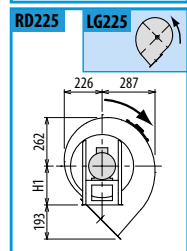
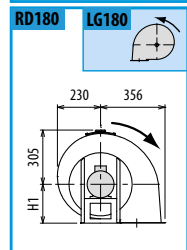
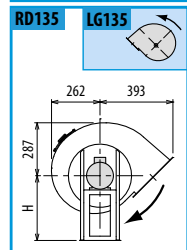
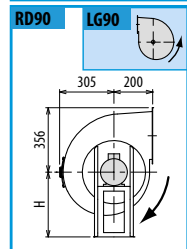
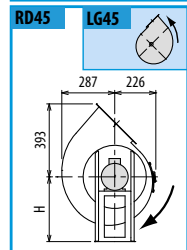
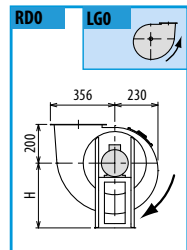

TIPO - Type		PESO Weight	PD ²	B	I	H	H1	H2	J	K	M	Q	R	Ø
VENTILATORE Fan	MOTORE Motor	Kg	Kgf x m ²											
RL280/2	80 B2	45	0,20	482	121	375	200	375	203	225	217	48	48	10
RL280/T		46	0,22			375	200	375						

pg. / s. 3.6

pg. / s. 3.5

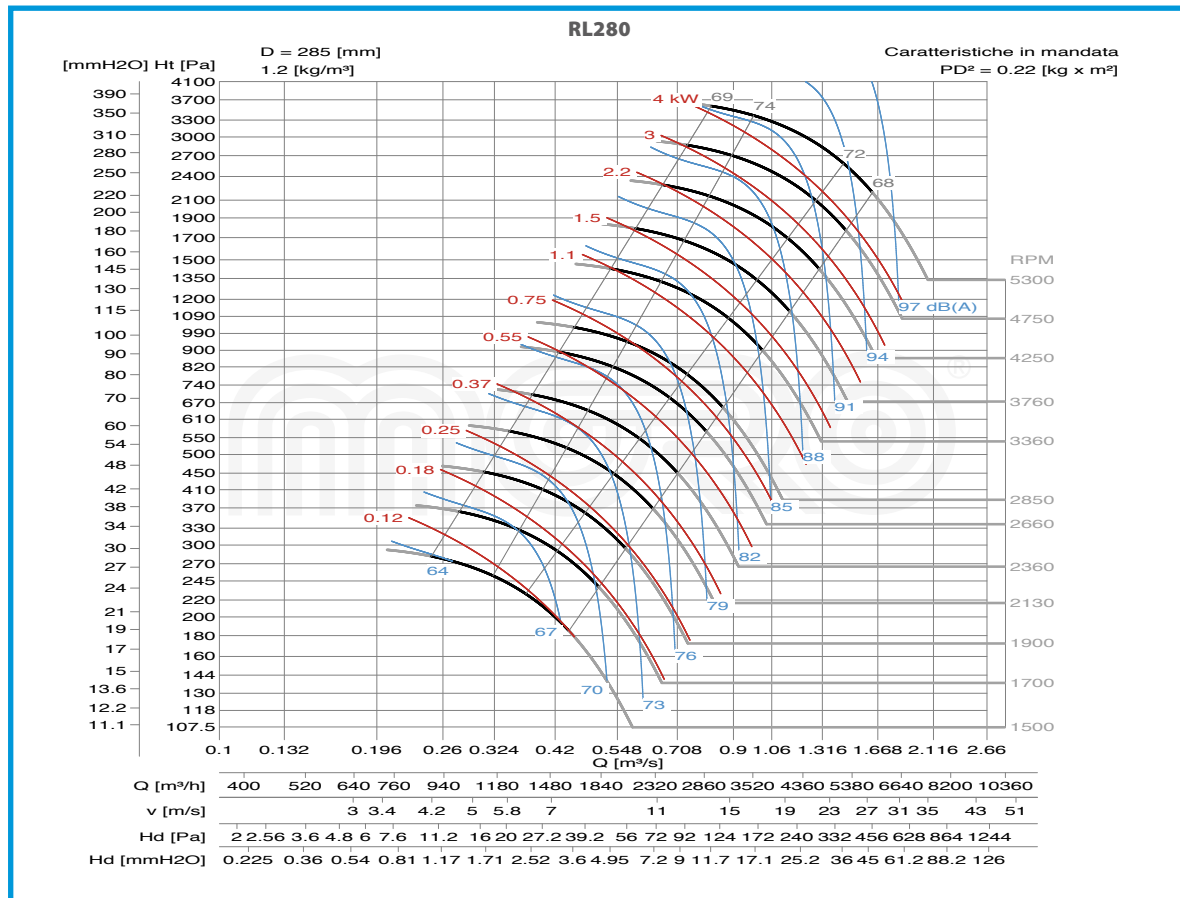

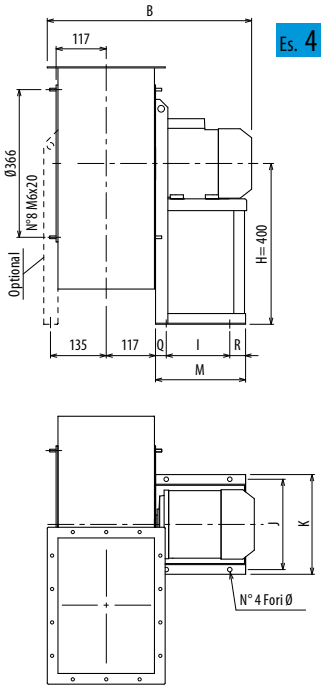

Es. 4

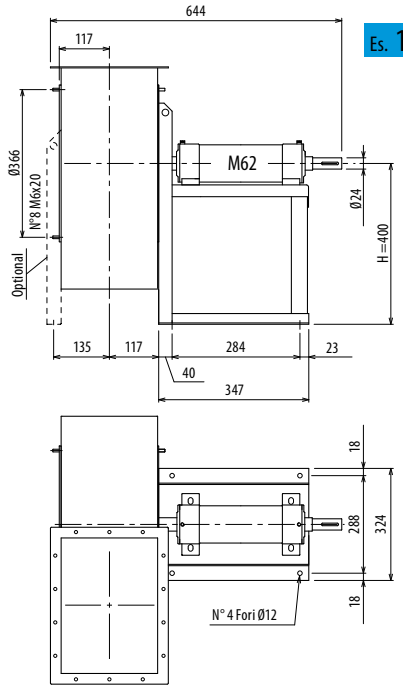

Es. 1

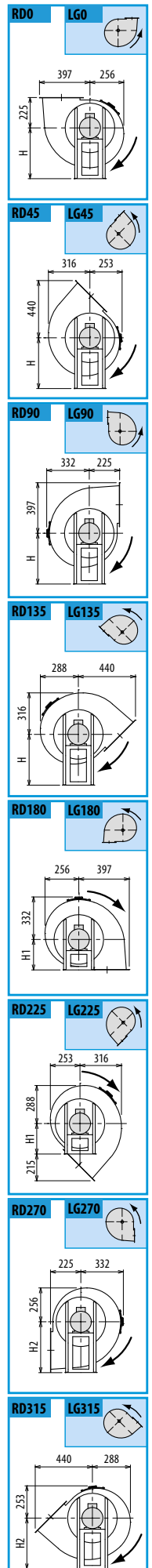
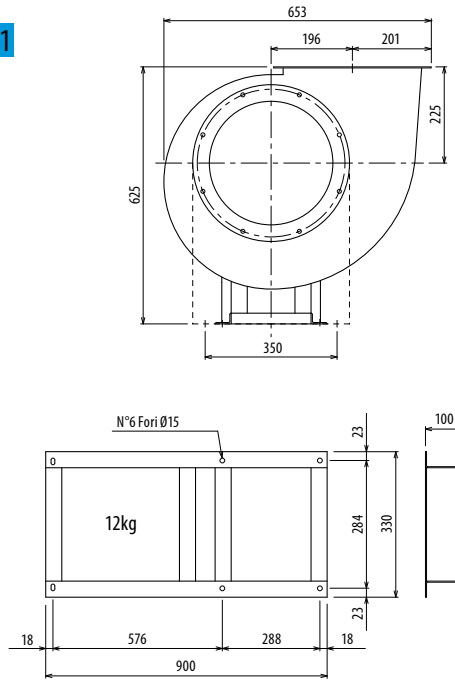

Il ventilatore è orientabile - Peso in tabella comprensivo di motore

- Le ventilateur est orientable
- The fan is revolvable
- Der Ventilator ist drehbar
- El ventilador es orientable
- Le poids dans le tableau inclut le moteur
- The weight indicated in the table includes motor
- Das Gewicht im Tafel schließt den Motor ein
- El peso en la tabla incluye el motor

Ulteriori informazioni e quote:
 ■ Ulérieures informations et cotes:
 ■ Further information and sizes:
 ■ Weitere Infos und Größen:
 ■ Más informaciones y medidas:

TIPO - Type		PESO Weight Kg	PD ² Kgf x m ²	B	I	H	H1	H2	J	K	M	Q	R	Ø
VENTILATORE Fan	MOTORE Motor													
RL310/2	90 L2	57	0,33	553	133	400	225	400	234	260	246	55	58	10
RL310/4	63 B4	43	0,33	452	86	400	225	400	184	206	145	45	14	10
RL310/T		50	0,33			400	225	400						

pg. / s. 3,6

pg. / s. 3,5

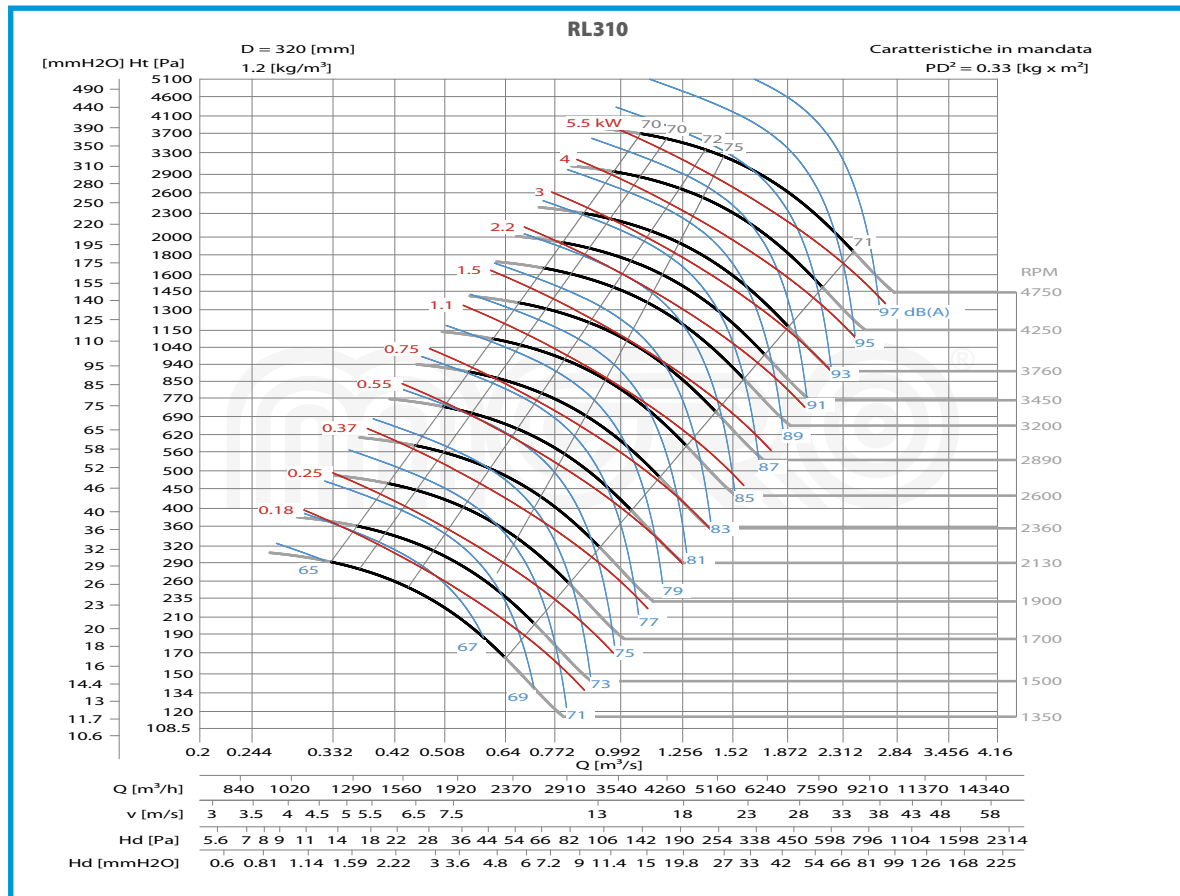

RL

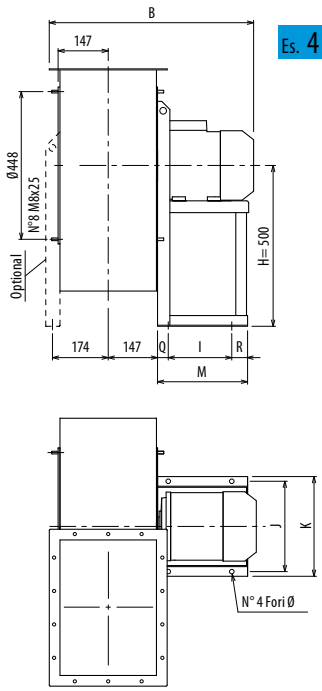

Es. 4

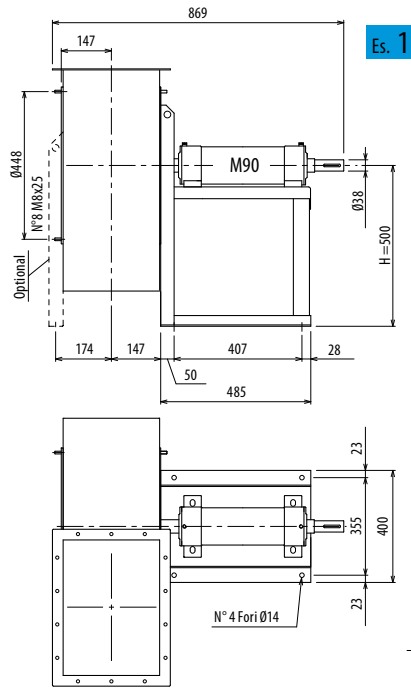

Es. 1

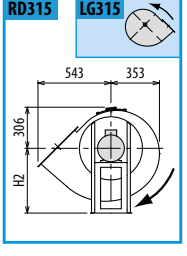
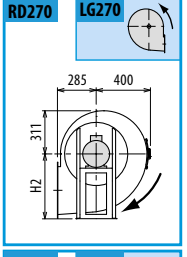
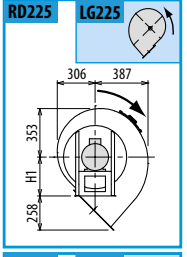
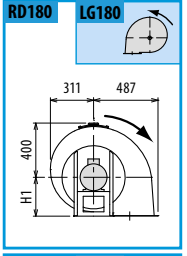
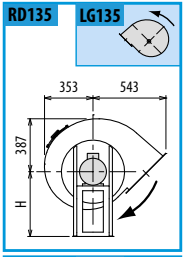
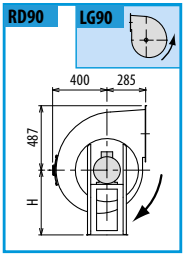
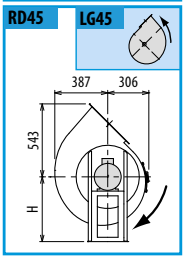
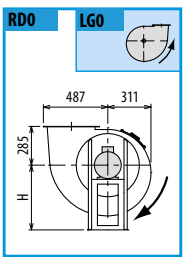
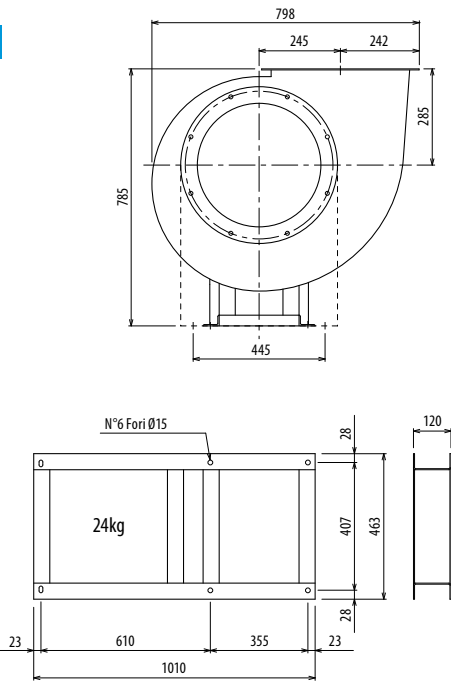

Il ventilatore è orientabile - Peso in tabella comprensivo di motore

- Le ventilateur est orientable
- The fan is revolvable
- Der Ventilator ist drehbar
- El ventilador es orientable
- Le poids dans le tableau inclut le moteur
- The weight indicated in the table includes motor
- Das Gewicht im Tafel schließt den Motor ein
- El peso en la tabla incluye el motor

Ulteriori informazioni e quote:
 ■ Ulérieures informations et cotes:
 ■ Further information and sizes:
 ■ Weitere Infos und Größen:
 ■ Más informaciones y medidas:

TIPO - Type		PESO Weight Kg	PD ² Kg f x m ²	B	I	H	H1	H2	J	K	M	Q	R	Ø
VENTILATORE Fan	MOTORE Motor													
RL400/2R	112 M2	95	0,82	664	197	500	285	500	289	324	276	30	49	12
RL400/2	132 S2	116	1,10	704	237	500	285	500	337	372	336	40	59	12
RL400/4R	80 A4	75	1,00	565	121	500	285	500	203	225	211	45	45	10
RL400/4	80 B4	75	1,00	565	121	500	285	500	203	225	211	45	45	10
RL400/T		92	1,1			500	285	500						

pg. / s. 3,6

pg. / s. 3,5

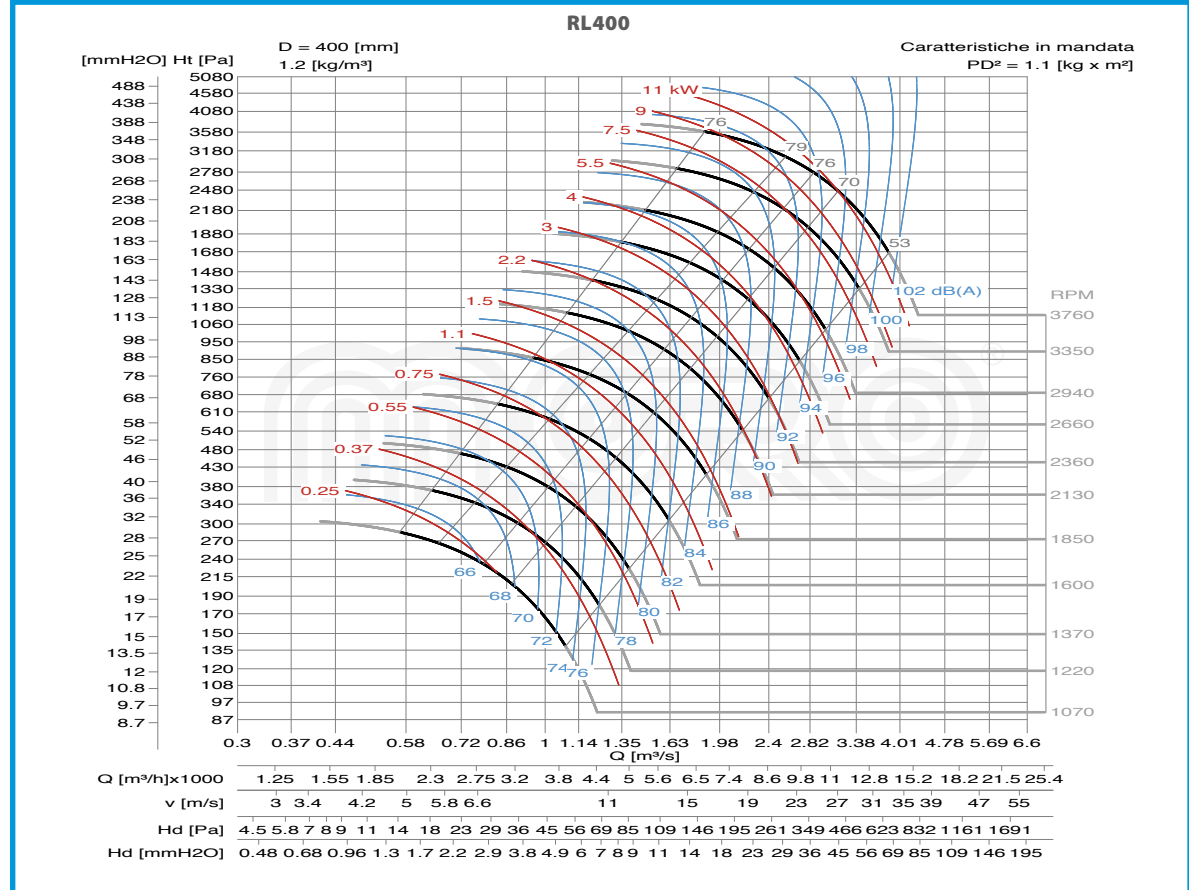
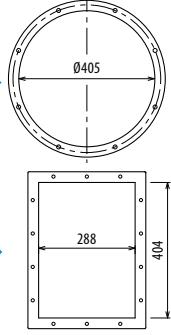

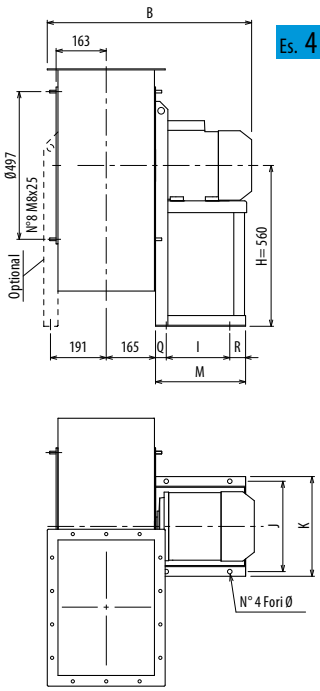

Es. 4

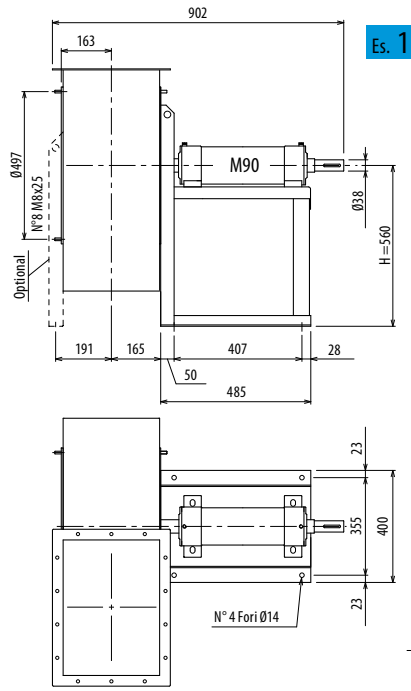

Es. 1

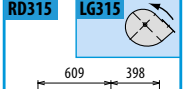
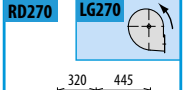
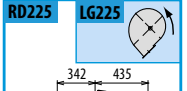
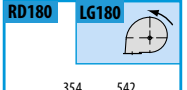
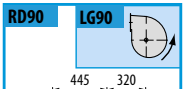
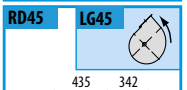
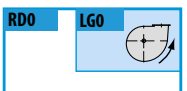
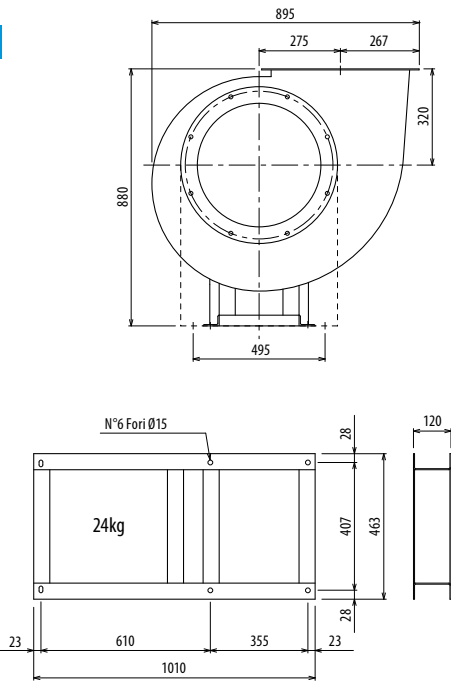

Il ventilatore è orientabile - Peso in tabella comprensivo di motore

- Le ventilateur est orientable
- The fan is revolvable
- Der Ventilator ist drehbar
- El ventilador es orientable
- Le poids dans le tableau inclut le moteur
- The weight indicated in the table includes motor
- Das Gewicht im Tafel schließt den Motor ein
- El peso en la tabla incluye el motor

Ulteriori informazioni e quote:
 ■ Ulterieurs informations et cotes:
 ■ Further information and sizes:
 ■ Weitere Infos und Größen:
 ■ Más informaciones y medidas:

TIPO - Type		PESO Weight Kg	PD² Kgf x m²	B	I	H	H1	H2	J	K	M	Q	R	Ø
VENTILATORE Fan	MOTORE Motor													
RL450/2R	132 S2	124	1,2	739	237	560	320	560	337	372	336	40	59	12
RL450/2	160 M2	161	1,9	844	337	560	320	560	395	440	436	50	49	14
RL450/4R	80 B4	89	1,0	600	121	560	320	560	203	225	211	45	45	10
RL450/4	90 S4	94	1,8	647	133	560	320	560	234	260	246	55	58	10
RL450/T		105	1,9			560	320	560						

pg. / s. 3.6

pg. / s. 3.5

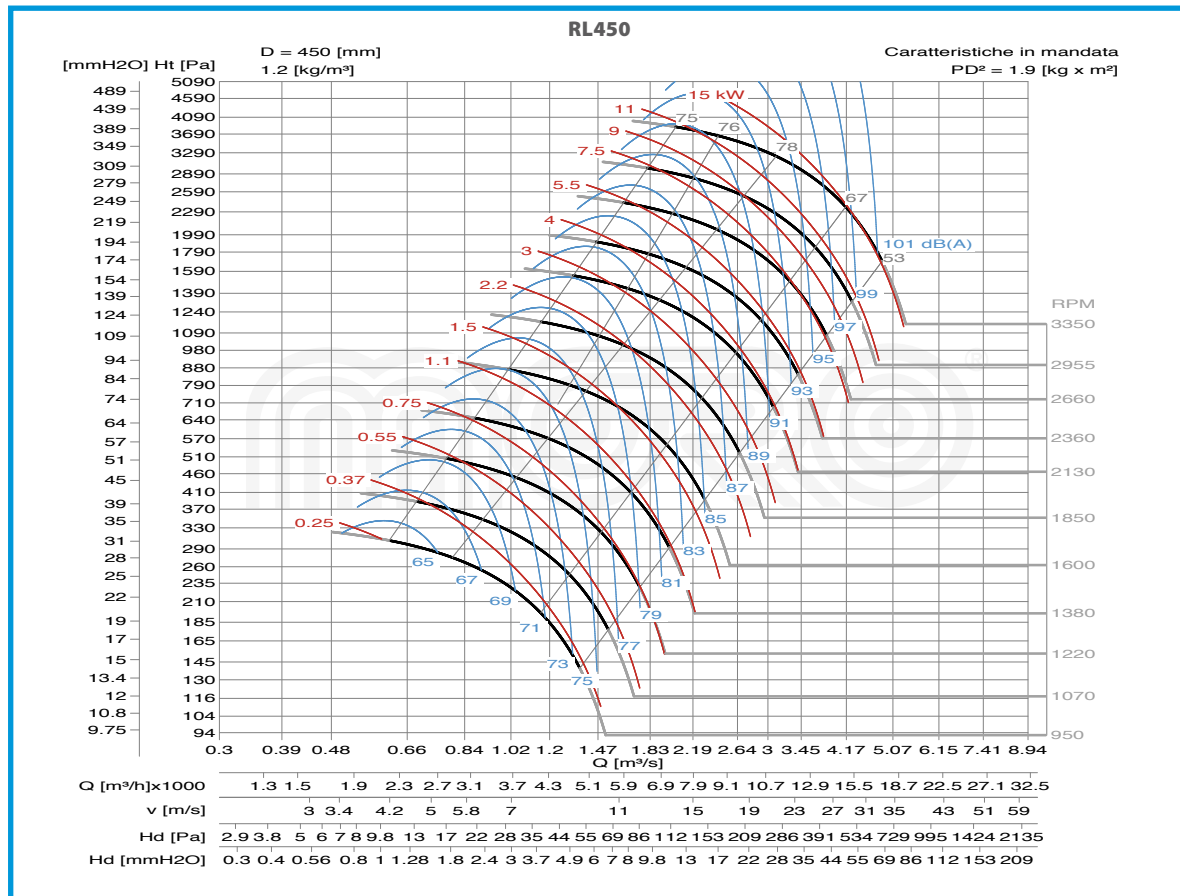

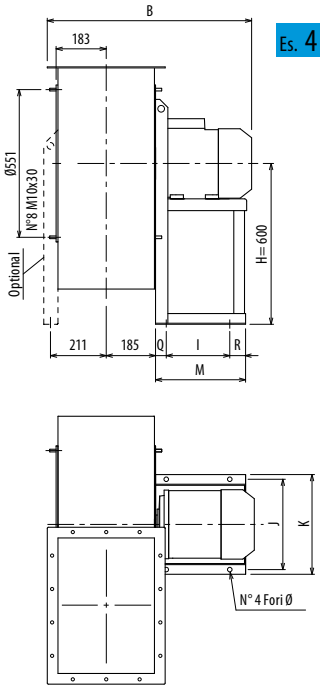

Es. 4

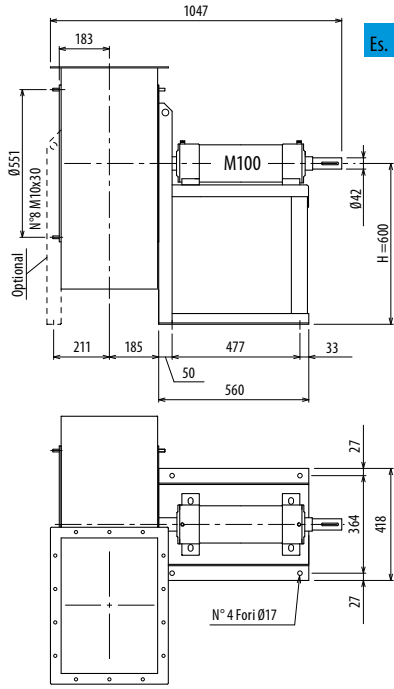

Es. 1

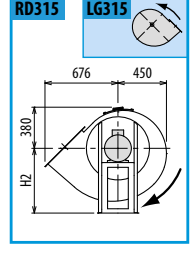
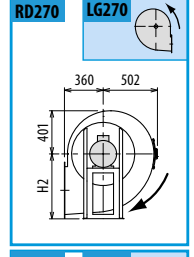
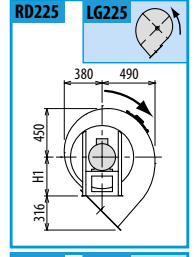
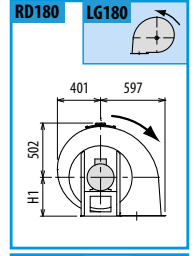
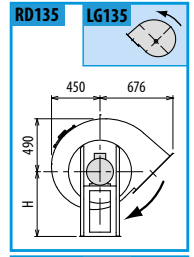
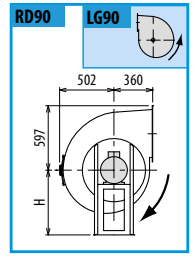
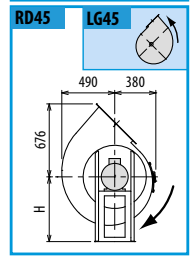
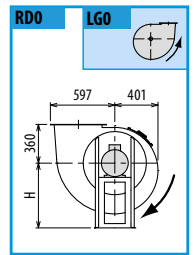
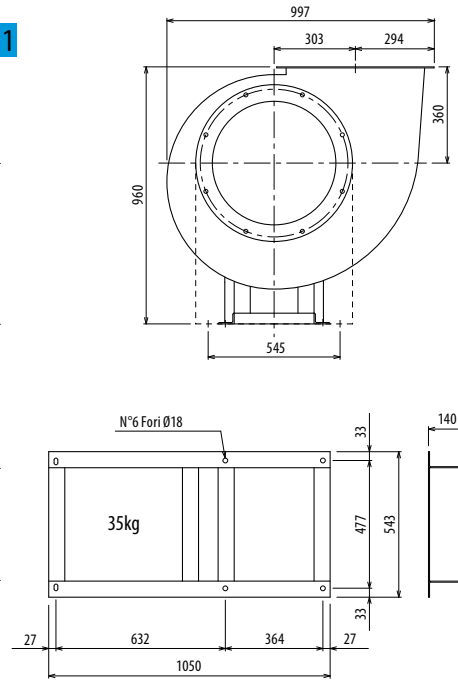

Il ventilatore è orientabile - Peso in tabella comprensivo di motore

- Le ventilateur est orientable
- The fan is revolvable
- Der Ventilator ist drehbar
- El ventilador es orientable
- Le poids dans le tableau inclut le moteur
- The weight indicated in the table includes motor
- Das Gewicht im Tafel schließt den Motor ein
- El peso en la tabla incluye el motor

Ulteriori informazioni e quote:
 ■ Ulérieures informations et cotes:
 ■ Further information and sizes:
 ■ Weitere Infos und Größen:
 ■ Más informaciones y medidas:

TIPO - Type		PESO Weight	PD ²	B	I	H	H1	H2	J	K	M	Q	R	Ø
VENTILATORE Fan	MOTORE Motor	Kg	Kgf x m ²											
RL500/2R	160 M2	187	2,4	884	337	600	360	600	395	440	436	50	49	14
RL500/2	160 L2	196	2,7	884	337	600	360	600	395	440	436	50	49	14
RL500/4R	90 L4	123	2,3	687	133	600	360	600	234	260	246	55	58	10
RL500/4	100 L4	130	2,6	718	197	600	360	600	289	324	276	30	49	12
RL500/6R	80 A6	115	2,2	640	121	600	360	600	203	225	211	45	45	10
RL500/6	80 B6	117	2,5	640	121	600	360	600	203	225	211	45	45	10
RL500/T		145	2,7			600	360	600						

pg. / s. 3.6

pg. / s. 3.5

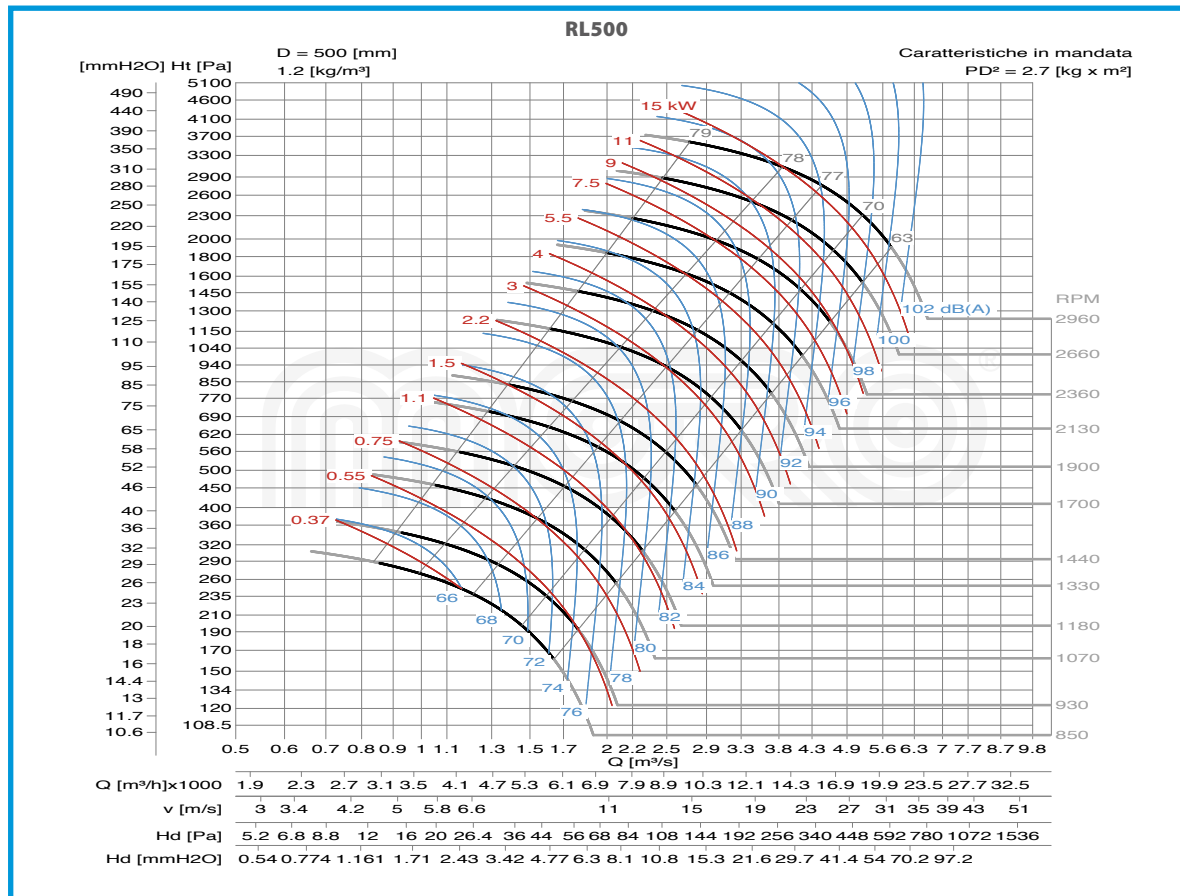
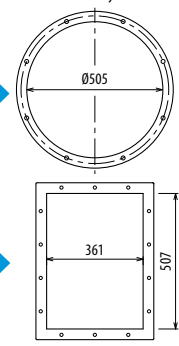

■ DIMENSIONS D'ENCOMBREMENT ET POIDS/COURBES DE FONCTIONNEMENT ■ OVERALL DIMENSIONS AND WEIGHT/WORKING CURVES
 ■ AUSMAß UND GEWICHTE/FUNKTIONSKURVEN ■ DIMENSIONES QUE OCUPA Y PESOS/CURVAS DE FUNCIONAMIENTO

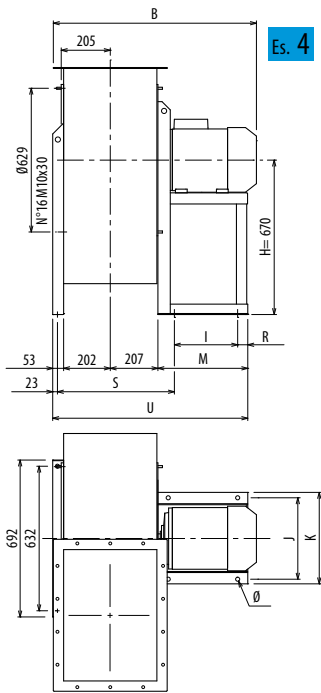

Es. 4

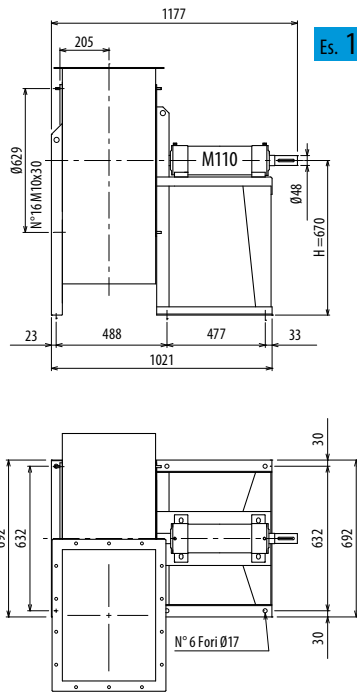

Es. 1

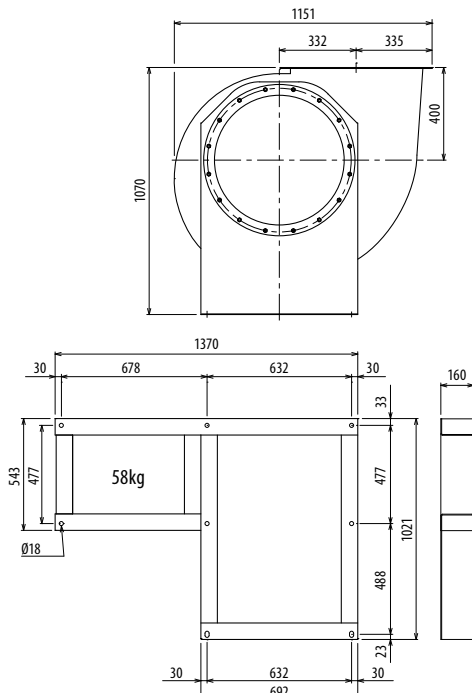

Il ventilatore è orientabile - Peso in tabella comprensivo di motore

■ Le ventilateur est orientable

■ The fan is revoluble

■ Der Ventilator ist drehbar

■ El ventilador es orientable

Le poids dans le tableau inclut le moteur

The weight indicated in the table includes motor

Gewichtangaben in Tabelle inkl. Motor

El peso en la tabla incluye el motor

Ulteriori informazioni e quote:

■ Ulérieures informations et cotes:

■ Further information and sizes:

■ Weitere Infos und Größen:

■ Más informaciones y medidas:

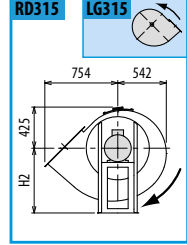
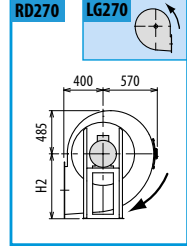
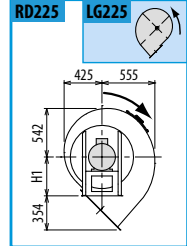
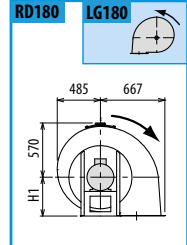
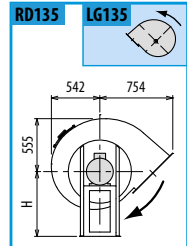
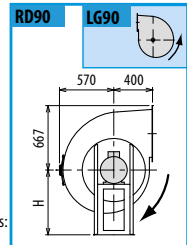
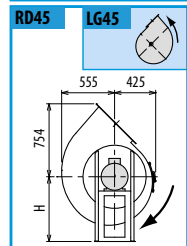
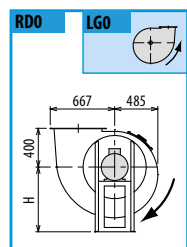

TIPO - Type		PESO Weight Kg	PD ² Kg f x m ²	B	I	H	H1	H2	J	K	M	R	S	U	Ø
VENTILATORE Fan	MOTORE Motor														
RL560/4R	100 L4	153	3,7	774	197	670	400	670	289	324	275	49	468	737	12
RL560/4	112 M4	158	4,3	795	197	670	400	670	289	324	275	49	468	737	12
RL560/6R	90 S6	141	3,5	743	133	670	400	670	234	260	245	58	493	707	10
RL560/6	90 L6	145	4,1	743	133	670	400	670	234	260	245	58	493	707	10
RL560/T		196	4,6			670	400	670							

pg. / S. 3,6

pg. / S. 3,5

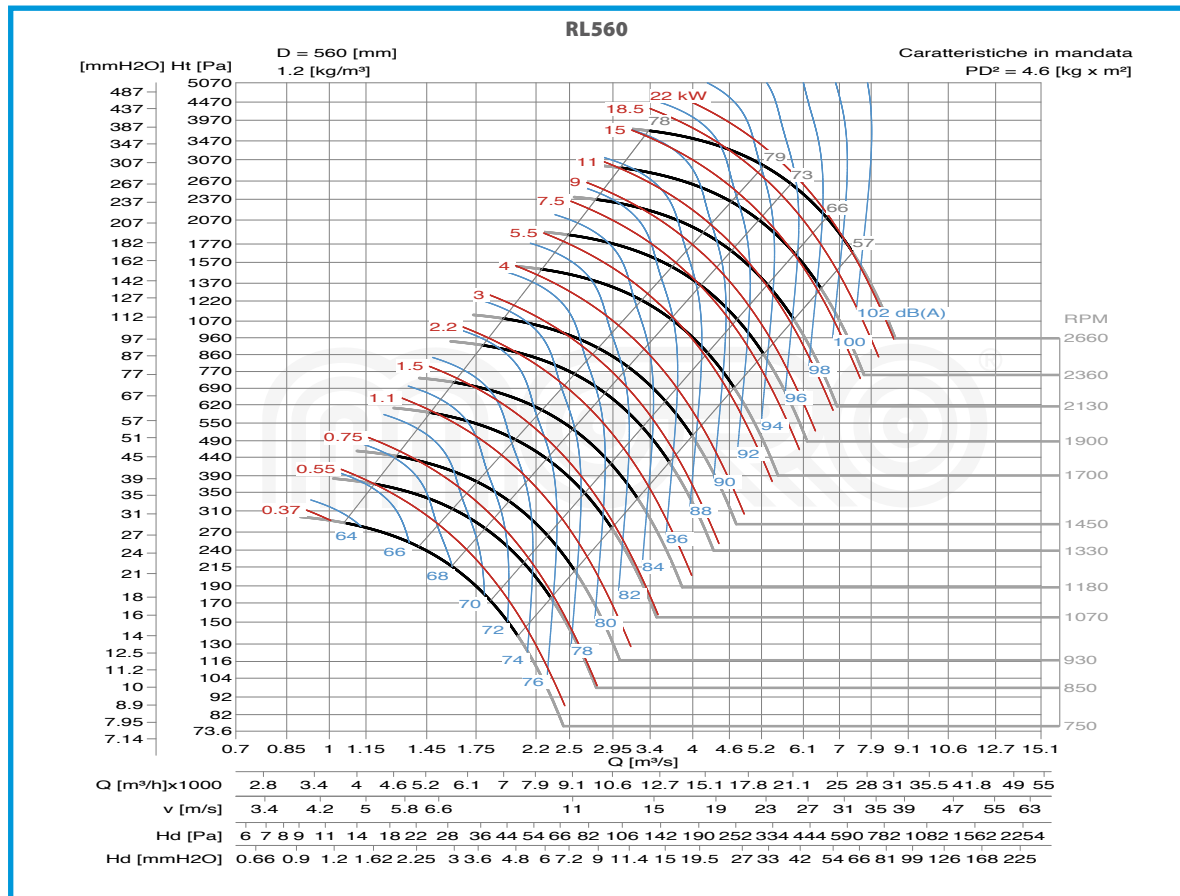
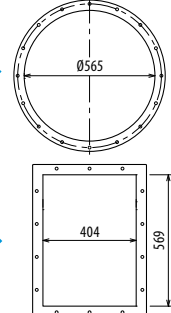

RL

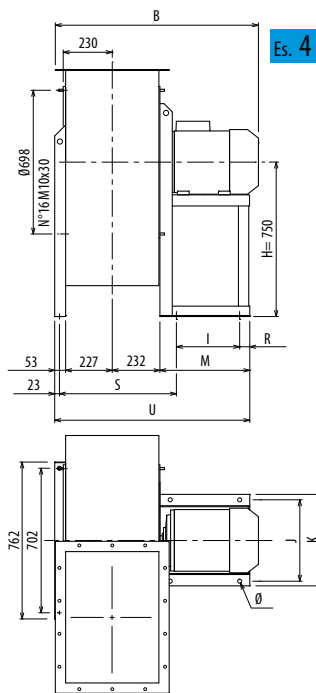

Es. 4

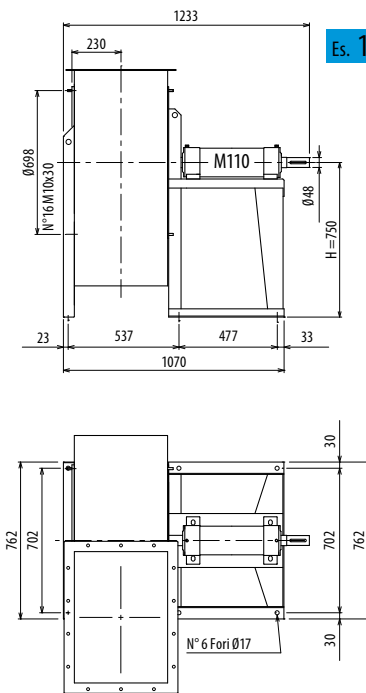

Es. 1

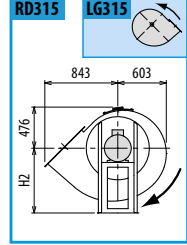
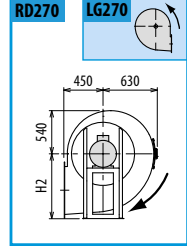
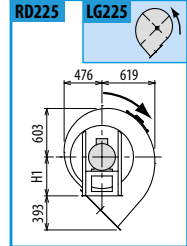
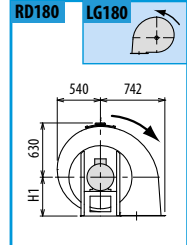
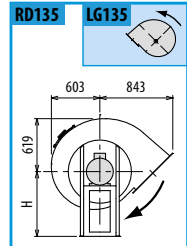
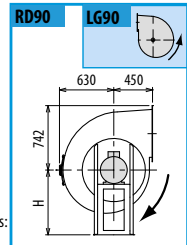
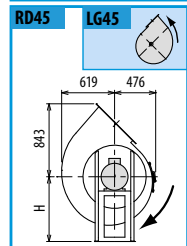
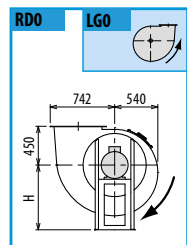
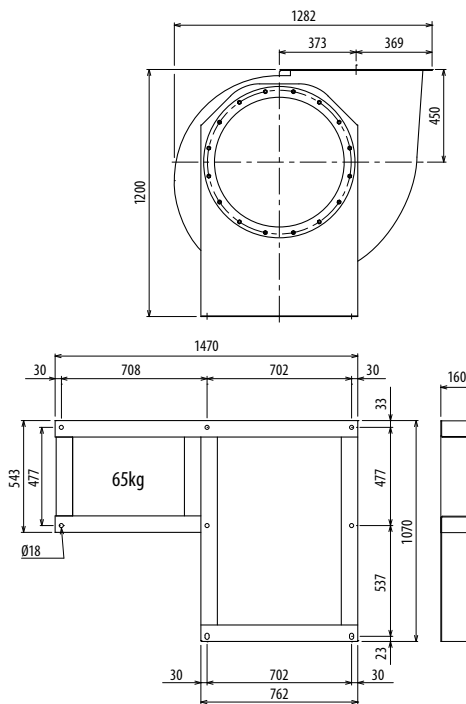

Il ventilatore è orientabile - Peso in tabella comprensivo di motore

■ Le ventilateur est orientable

■ The fan is revoluble

■ Der Ventilator ist drehbar

■ El ventilador es orientable

Le poids dans le tableau inclut le moteur

The weight indicated in the table includes motor

Gewichtsangabe in Tabelle inkl. Motor

El peso en la tabla incluye el motor

Ulteriori informazioni e quote:

■ Ulérieures informations et cotes:

■ Further information and sizes:

■ Weitere Infos und Größen:

■ Más informaciones y medidas:

TIPO - Type		PESO Weight Kg	PD ² Kgf x m ²	B	I	H	H1	H2	J	K	M	R	S	U	Ø
VENTILATORE Fan	MOTORE Motor														
RL630/4R	132 S4	202	6,2	885	237	750	450	750	337	372	335	59	527	846	12
RL630/4	132 M4	214	7,5	885	237	750	450	750	337	372	335	59	527	846	12
RL630/6R	100 L6	173	6	824	197	750	450	750	289	324	275	49	517	786	12
RL630/6	112 M6	180	7,2	845	197	750	450	750	289	324	275	49	517	786	12
RL630/T		239	8,1			750	450	750							

pg. / s. 3.6

pg. / s. 3.5

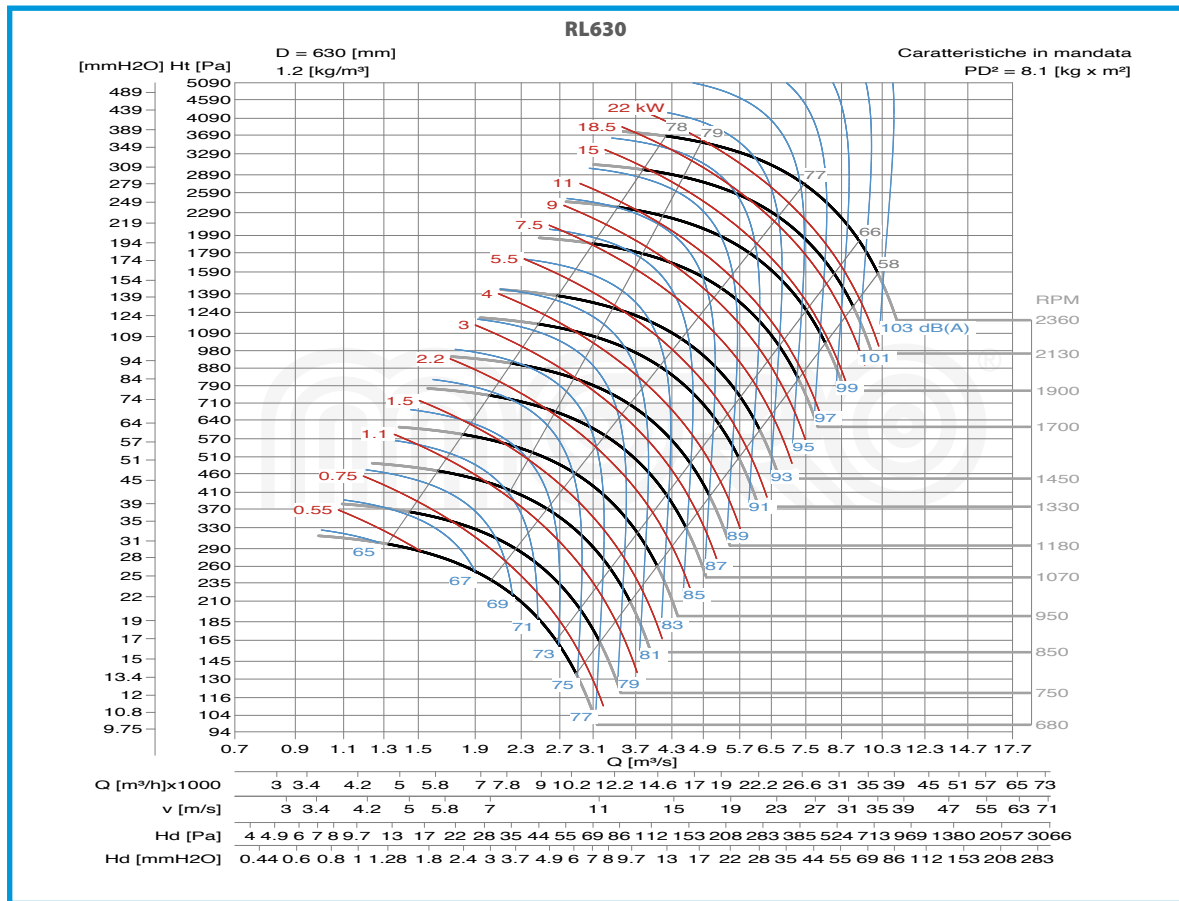
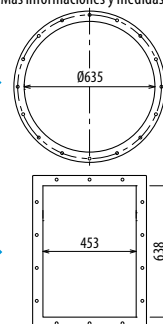

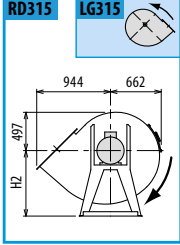
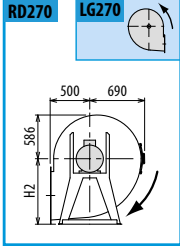
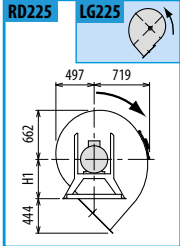
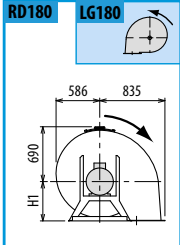
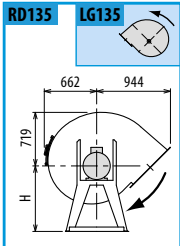
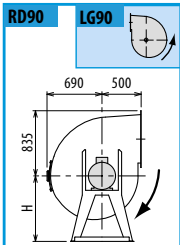
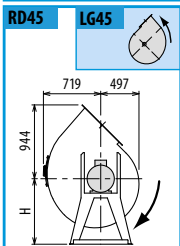
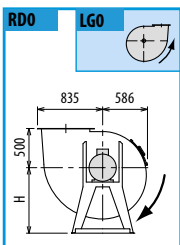
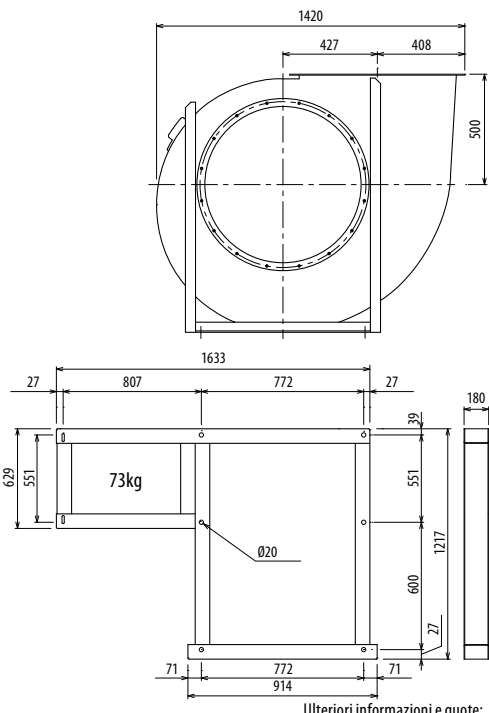
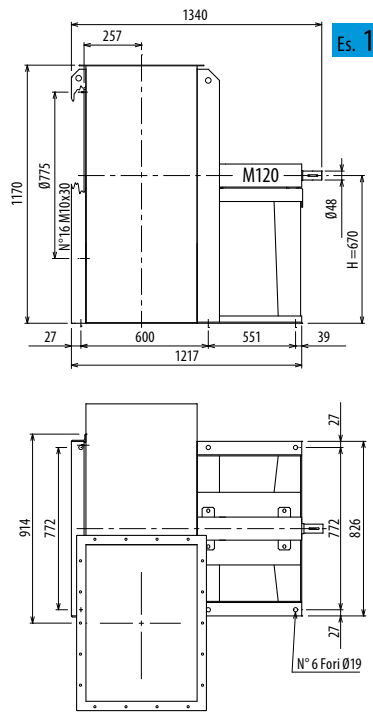
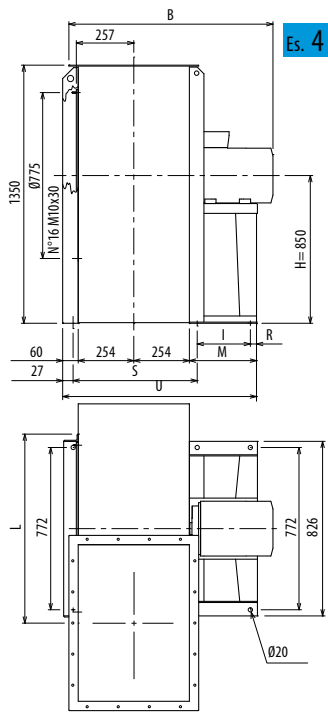

Il ventilatore non è orientabile - Peso in tabella comprensivo di motore

■ Le ventilateur n'est pas orientable ■ The fan is not revolvable ■ Der Ventilator ist nicht drehbar ■ El ventilador no es orientable
 ■ Le poids dans le tableau inclut le moteur ■ The weight indicated in the table includes motor ■ Das Gewicht in Tafel schließt den Motor ein ■ El peso en la tabla incluye el motor

Ulteriori informazioni e quote:
 ■ Ulérieures informations et cotes:
 ■ Further information and sizes:
 ■ Weitere Infos und Größen:
 ■ Más informaciones y medidas:

TIPO - Type		PESO Weight Kg	PD ² Kgf x m ²	B	I	H	H1	H2	L	R	M	S	U
VENTILATORE Fan	MOTORE Motor												
RL710/4R*	160 M4	315	13	1045	316	850	500	850	832	60	439	606	1009
RL710/4*	160 L4	326	15	1045	316	850	500	850	832	60	439	606	1009
RL710/6R*	132 S6	276	13	940	201	850	500	850	832	75	336	606	909
RL710/6*	132 M6	286	15	940	201	850	500	850	832	75	336	606	909
RL710/T		360	16			670	500	850					

* Il ventilatore è orientabile ■ * Le ventilateur est orientable ■ * The fan is revolvable ■ * Der Ventilator ist drehbar ■ * El ventilador es orientable

pg. / s. 3.6

pg. / s. 3.5

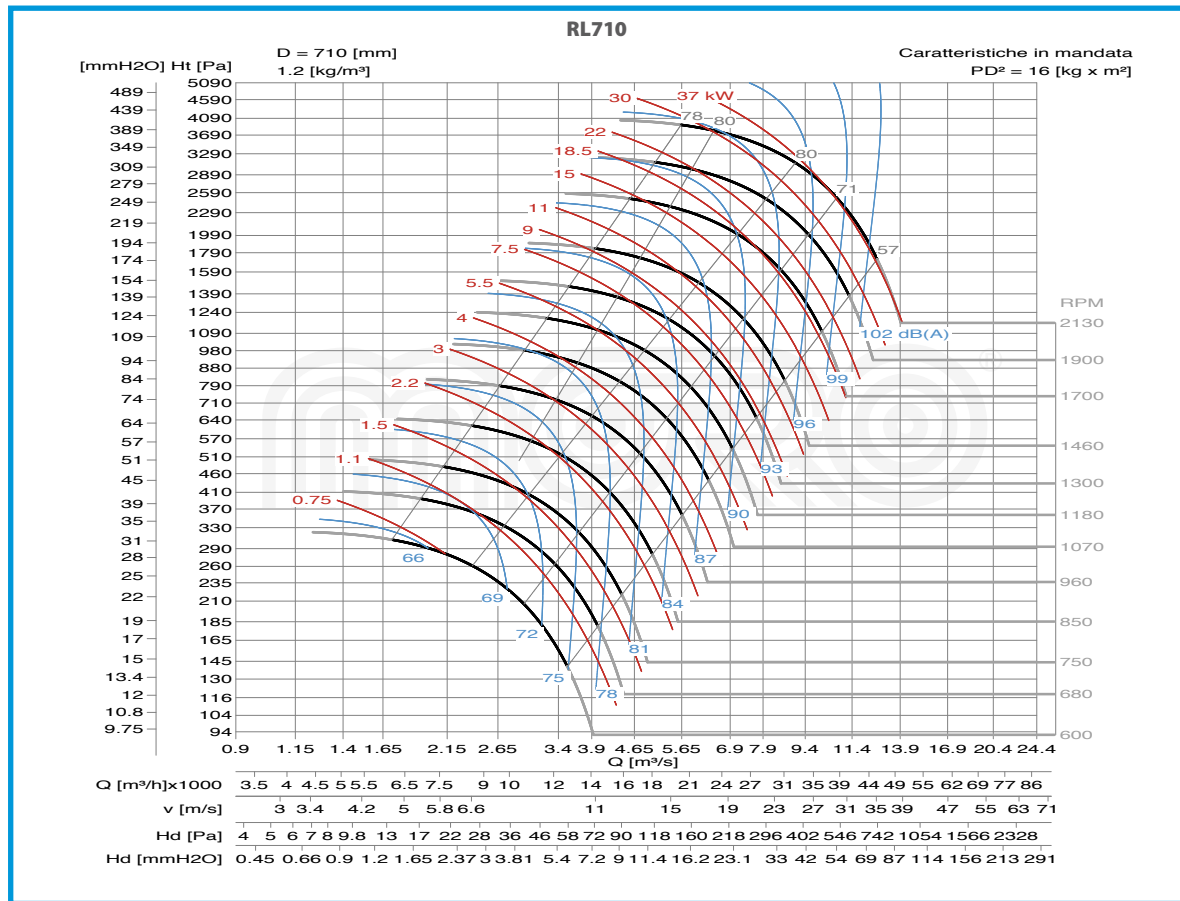

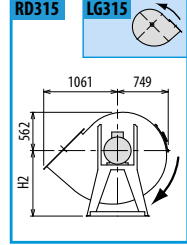
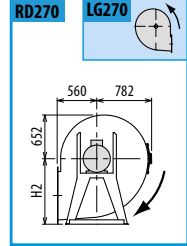
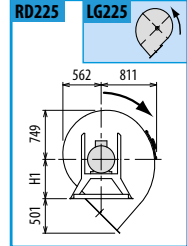
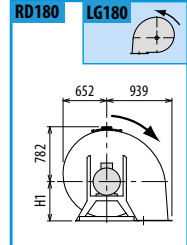
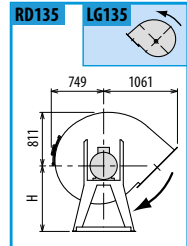
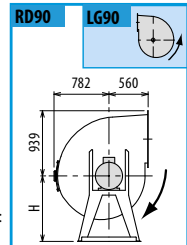
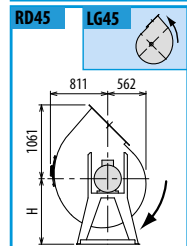
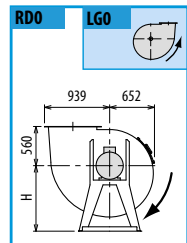
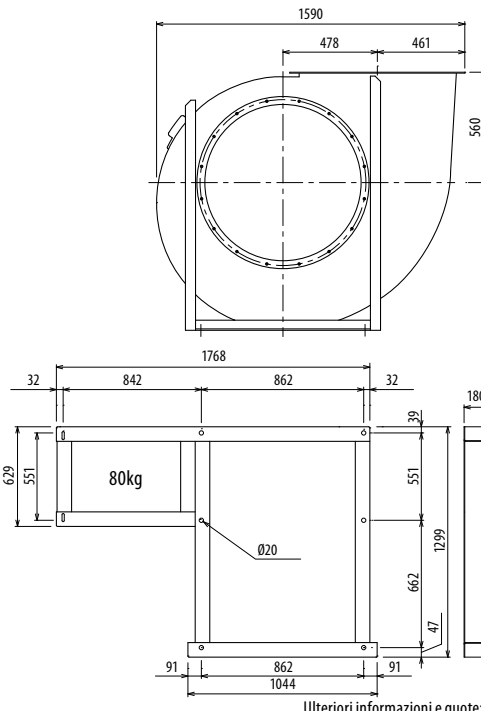
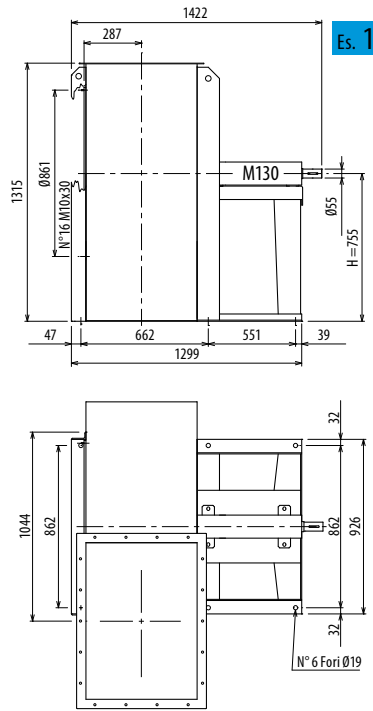
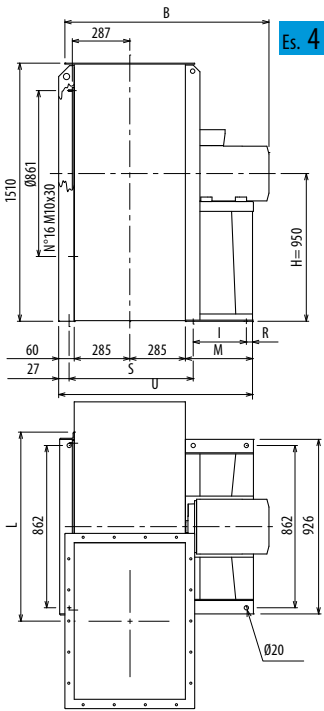

Il ventilatore non è orientabile - Peso in tabella comprensivo di motore

■ Le ventilateur n'est pas orientable ■ The fan is not revolvable ■ Der Ventilator ist nicht drehbar ■ El ventilador no es orientable
 ■ Le poids dans le tableau inclut le moteur ■ The weight indicated in the table includes motor ■ Das Gewicht im Tafel schließt den Motor ein ■ El peso en la tabla incluye el motor

TIPO - Type		PESO Weight Kg	PD ² Kgf x m ²	B	I	H	H1	H2	L	R	M	S	U
VENTILATORE Fan	MOTORE Motor												
RL800/4R*	180 M4	465	25	1188	361	950	560	950	932	39	463	668	1095
RL800/4*	180 L4	484	30	1239	361	950	560	950	932	39	463	668	1095
RL800/6R*	132 M6	367	20	1002	201	950	560	950	932	75	336	668	971
RL800/6*	160 M6	397	25	1107	316	950	560	950	932	60	439	668	1071
RL800/T		442	30			755	560	950					

* Il ventilatore è orientabile ■ * Le ventilateur est orientable ■ * The fan is revolvable ■ * Der Ventilator ist drehbar ■ * El ventilador es orientable

Ulteriori informazioni e quote:
 ■ Ulérieures informations et cotes:
 ■ Further information and sizes:
 ■ Weitere Infos und Größen:
 ■ Más informaciones y medidas:

pg. / s.
3.6

pg. / s.
3.5

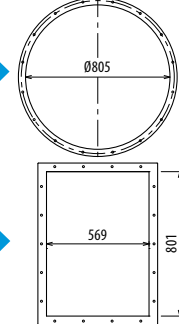

RL800

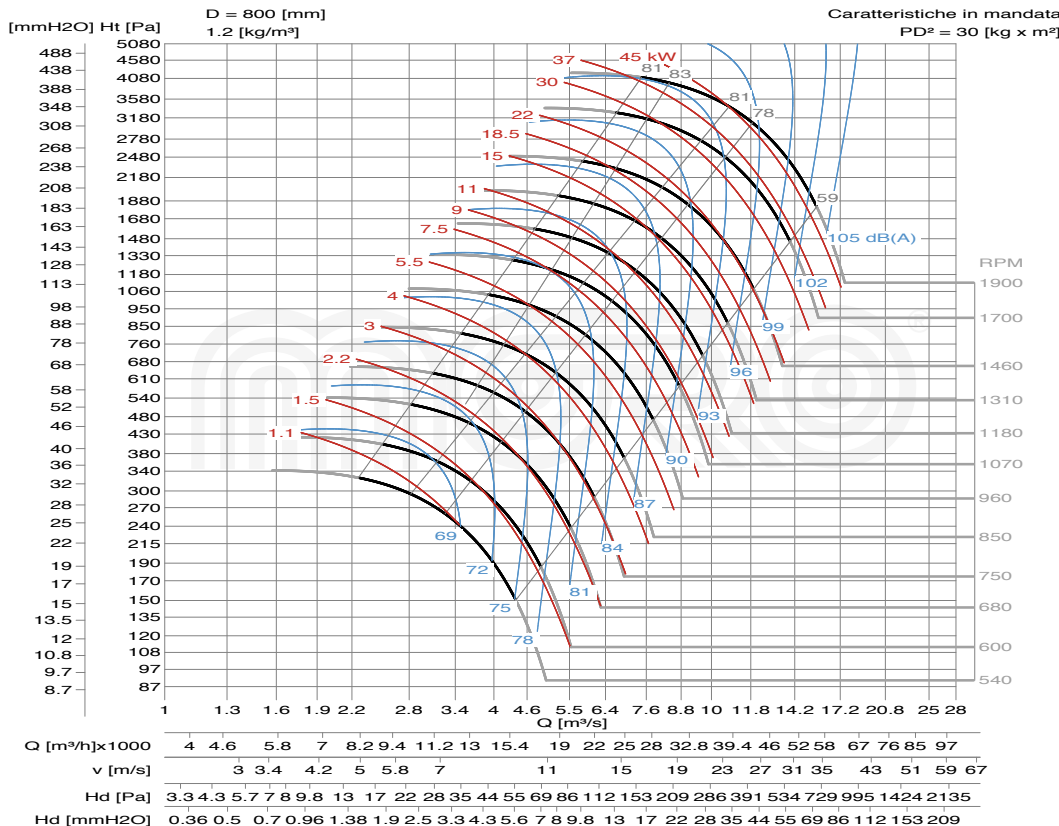

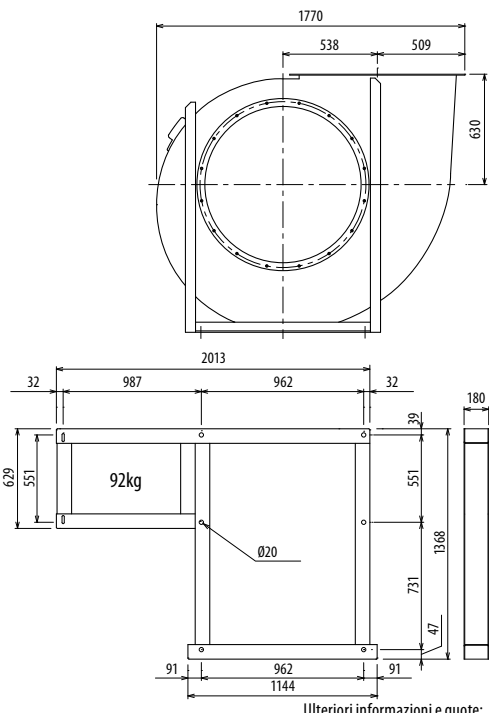
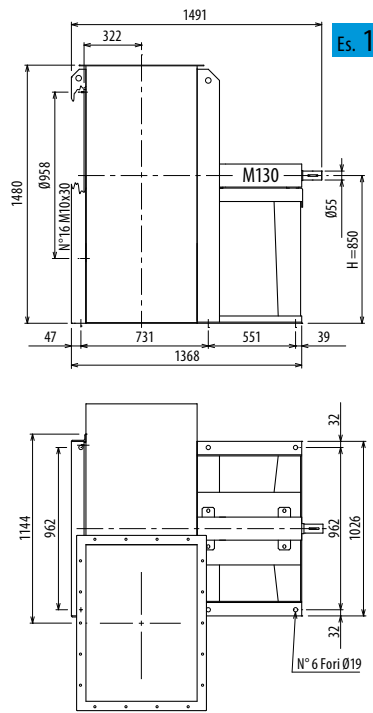
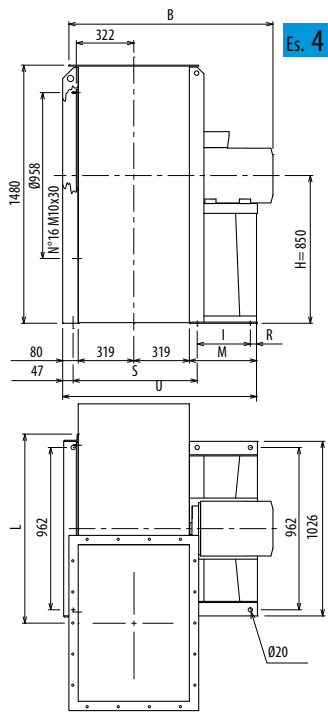

Il ventilatore non è orientabile - Peso in tabella comprensivo di motore

- Le ventilateur n'est pas orientable
 - The fan is not revolvable
 - Der Ventilator ist nicht drehbar
 - El ventilador no es orientable
- The weight indicated in the table includes motor Das Gewicht in Tafel schließt den Motor ein El peso en la tabla incluye el motor

Ulteriori informazioni e quote:
 ■ Ulérieures informations et cotes:
 ■ Further information and sizes:
 ■ Weitere Infos und Größen:
 ■ Más informaciones y medidas:

TIPO - Type		PESO Weight Kg	PD ² Kgf x m ²	B	I	H	H1	H2	L	R	M	S	U
VENTILATORE Fan	MOTORE Motor												
RL900/4R	225 S4	840	40	1367	441	850	630	1060	1145	39	540	731	1258
RL900/4	225 M4	847	45	1427	441	850	630	1060	1145	39	540	731	1258
RL900/6R	160 L6	556	35	1196	316	850	630	1060	1145	60	436	731	1154
RL900/6	180 L6	658	40	1328	361	850	630	1060	1145	39	460	731	1178
RL900/T		570	45			850	630	1060					

pg. / s. 3.6

pg. / s. 3.5

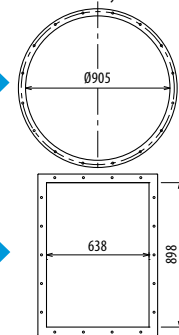

RD0 LG0

RD45 LG45

RD90 LG90

RD135 LG135

RD180 LG180

RD225 LG225

RD270 LG270

RD315 LG315

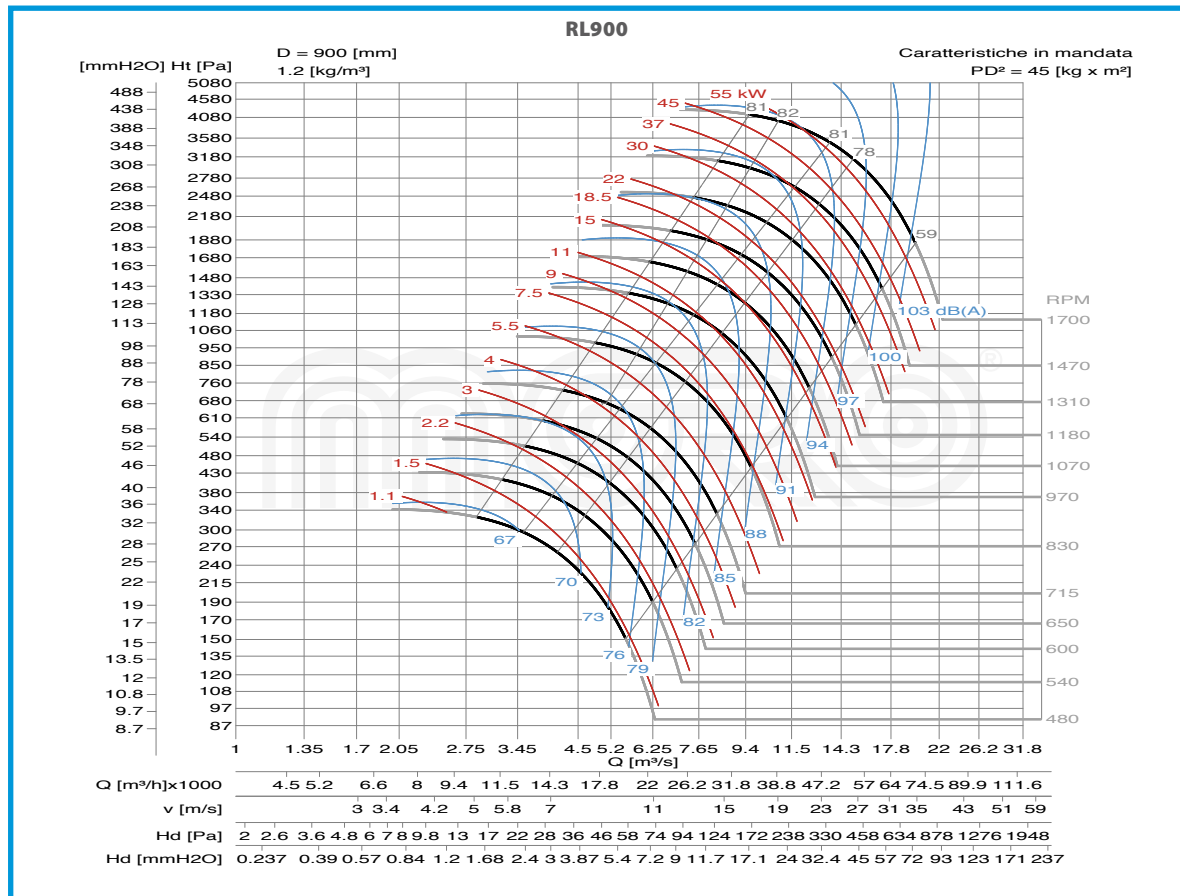

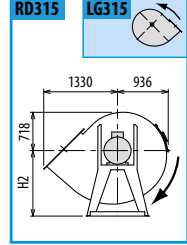
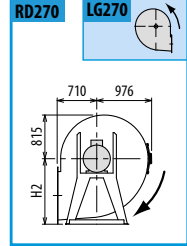
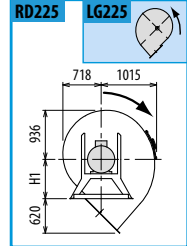
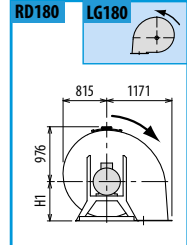
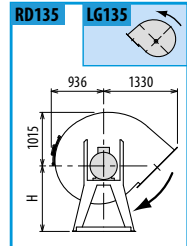
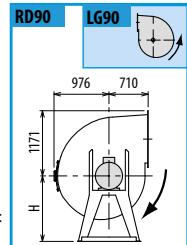
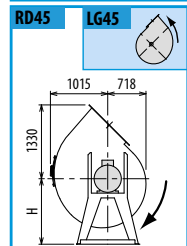
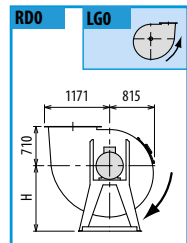
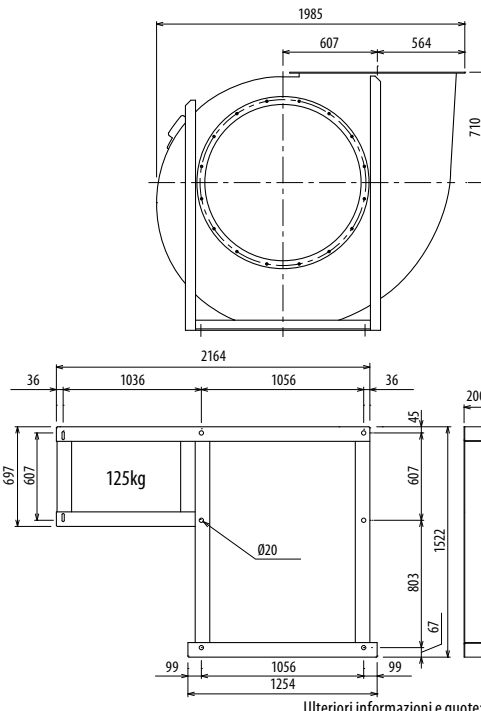
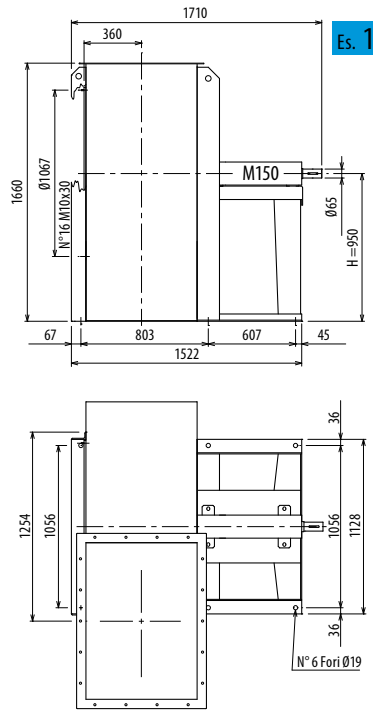
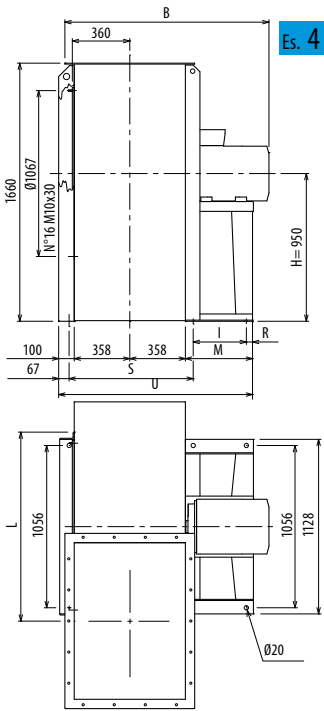

Il ventilatore non è orientabile - Peso in tabella comprensivo di motore

- Le ventilateur n'est pas orientable
- The fan is not revolvable
- Der Ventilator ist nicht drehbar
- El ventilador no es orientable
- Le poids dans le tableau inclut le moteur
- The weight indicated in the table includes motor
- Das Gewicht in Tafel schließt den Motor ein
- El peso en la tabla incluye el motor
- Más informaciones y medidas:

TIPO - Type		PESO Weight	PD ²												
VENTILATORE Fan	MOTORE Motor	Kg	Kgf x m ²	B	I	H	H1	H2	L	R	M	S	U		
RL1000/4R	250 M4	1105	70	1632	500	950	710	1180	1255	45	600	803	1415		
RL1000/4	280 S4	1278	75	1635	590	950	710	1180	1255	45	690	803	1505		
RL1000/6R	200 L6	879	65	1482	400	950	710	1180	1255	45	500	803	1315		
RL1000/6	200 L6	885	70	1482	400	950	710	1180	1255	45	500	803	1315		
RL1000/T		800	75			950	710	1180							

Ulteriori informazioni e quote:
 ■ Ulérieures informations et cotes:
 ■ Further information and sizes:
 ■ Weitere Infos und Größen:
 ■ Más informaciones y medidas:

pg. / s. 3,6
 pg. / s. 3,5

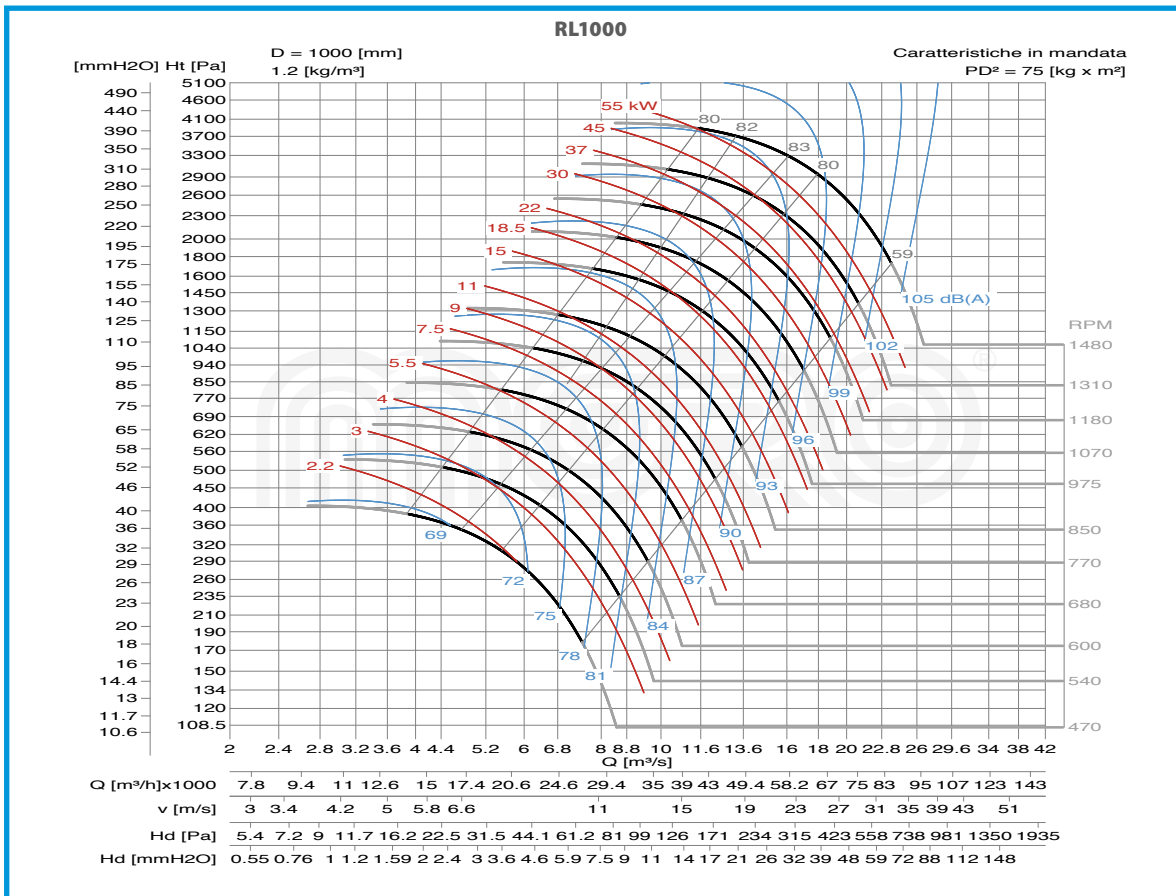
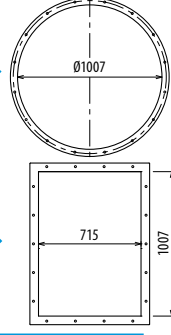

DIMENSIONI D'INGOMBRO E PESI/CURVE DI FUNZIONAMENTO

RL1120



■ DIMENSIONS D'ENCREMBREMENT ET POIDS/COURBES DE FONCTIONNEMENT ■ OVERALL DIMENSIONS AND WEIGHT/WORKING CURVES
 ■ AUSMAß UND GEWICHTE/FUNKTIONSKURVEN ■ DIMENSIONES QUE OCUPA Y PESOS/CURVAS DE FUNCIONAMIENTO

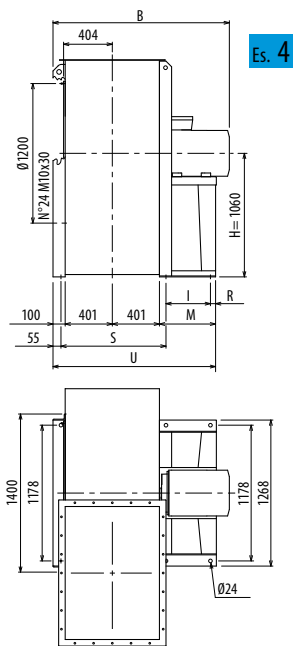

Es. 4

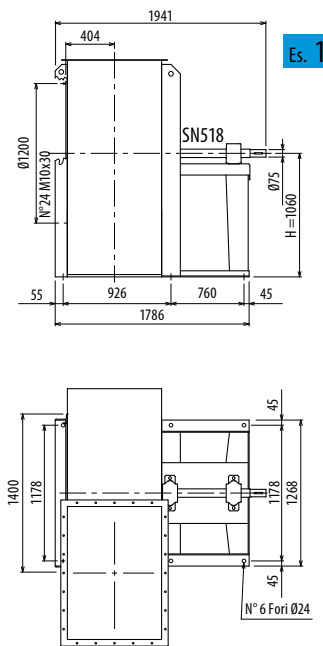

Es. 1

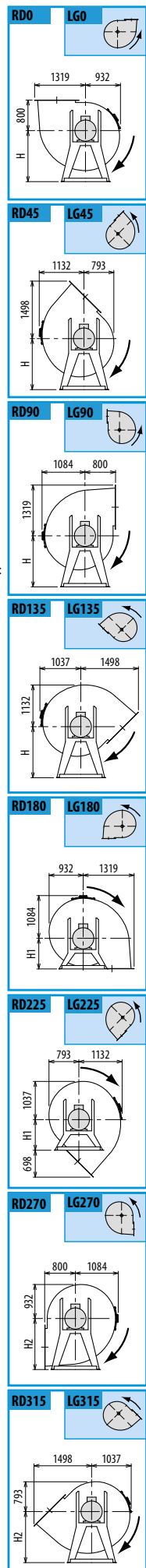
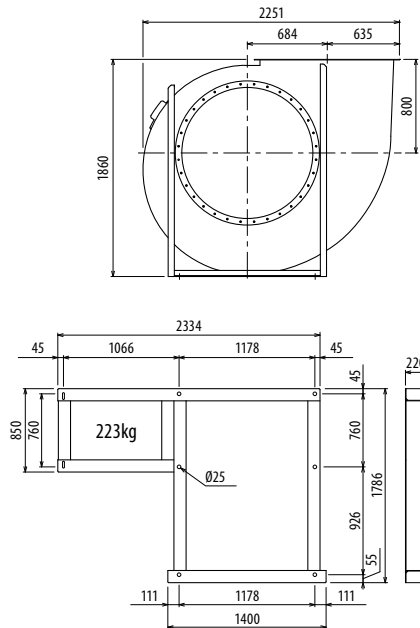

Il ventilatore non è orientabile • Peso in tabella comprensivo di motore

■ Le ventilateur n'est pas orientable ■ The fan is not revolvable ■ Der Ventilator ist nicht drehbar ■ El ventilador no es orientable
 Le poids dans le tableau inclut le moteur The weight indicated in the table includes motor Das Gewicht im Tafel schließt den Motor ein El peso en la tabla incluye el motor

Ulteriori informazioni e quote:
 ■ Ulérieures informations et cotes:
 ■ Further information and sizes:
 ■ Weitere Infos und Größen:
 ■ Más informaciones y medidas:

TIPO • Type		PESO Weight	PD ²	B	I	H	H1	H2	R	S	M	U
VENTILATORE Fan	MOTORE Motor	Kg	Kgf x m ²									
RL1120/6R	225 M6	1153	115	1611	415	1060	800	1320	45	926	540	1441
RL1120/6	250 M6	1242	130	1719	475	1060	800	1320	45	926	600	1501
RL1120/T		1065	135			1060	800	1320				

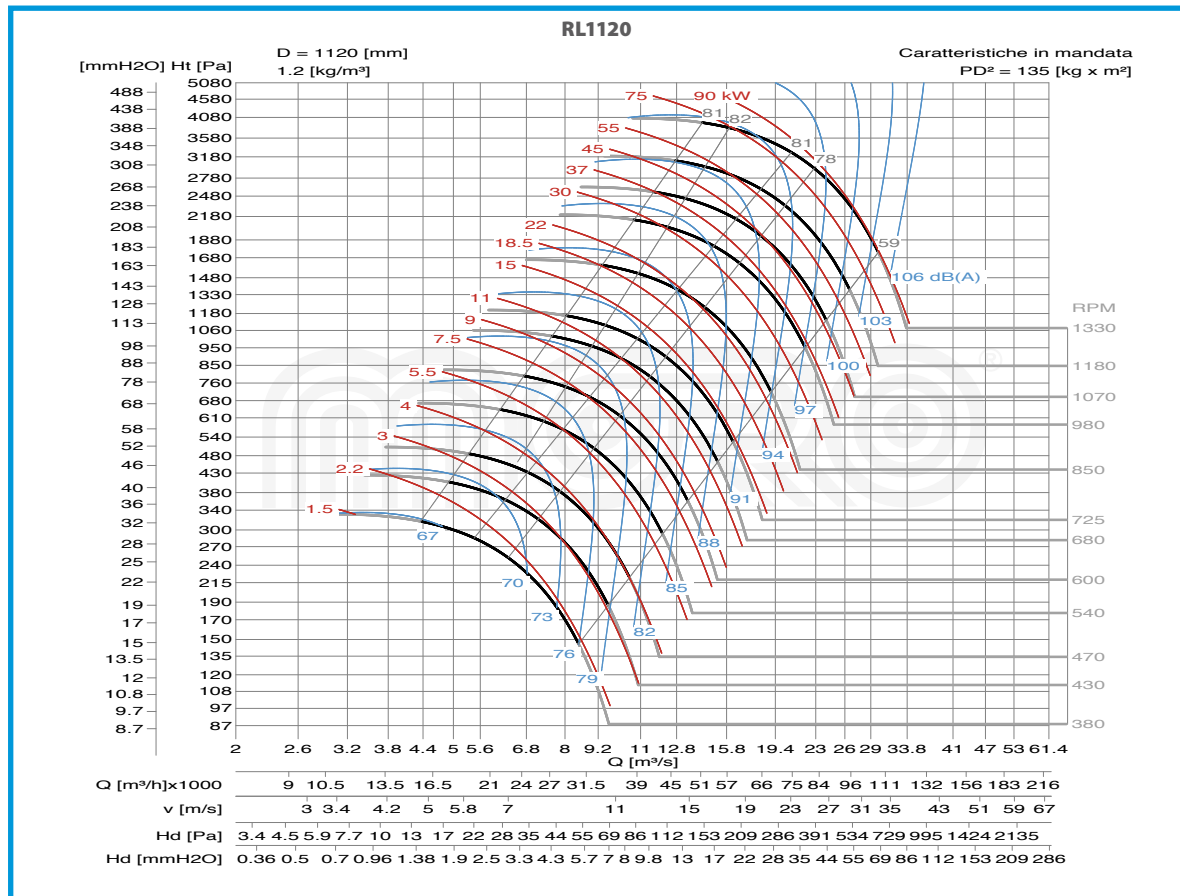
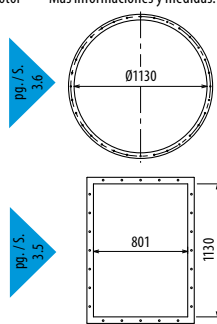

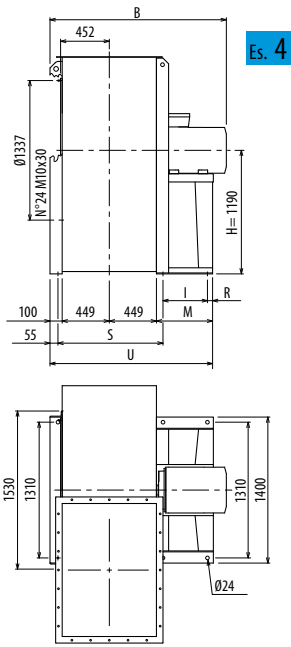

Es. 4

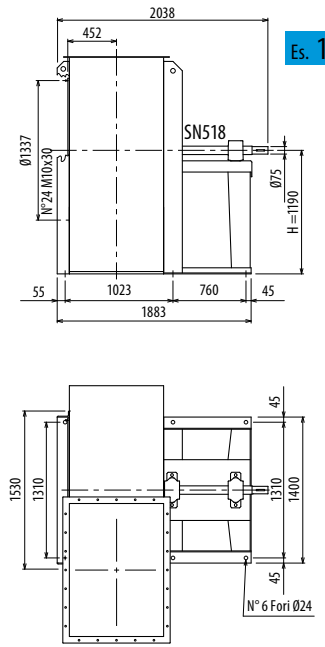

Es. 1

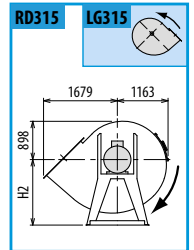
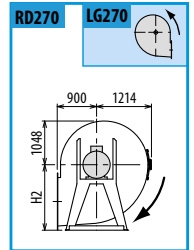
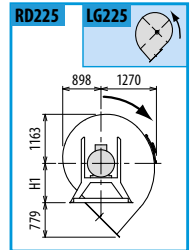
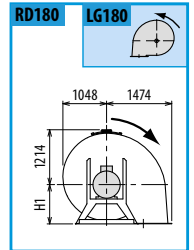
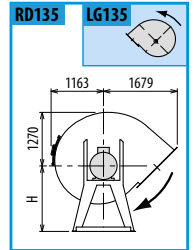
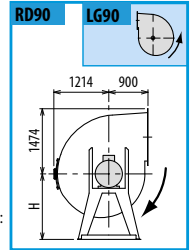
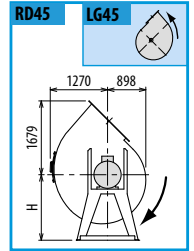
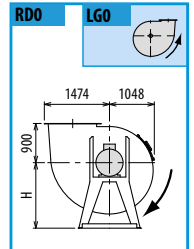
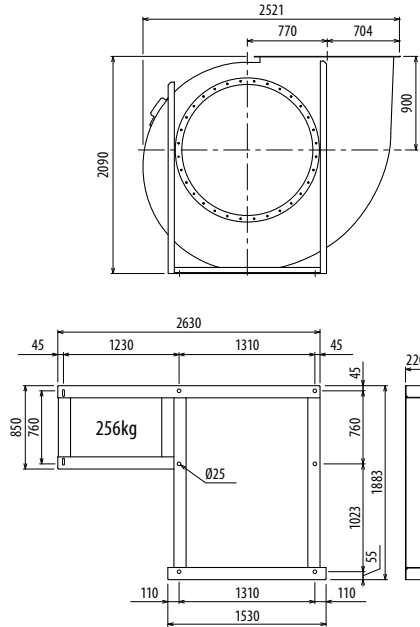

Il ventilatore non è orientabile • Peso in tabella comprensivo di motore

■ Le ventilateur n'est pas orientable ■ The fan is not revolvable

■ Der Ventilator ist nicht drehbar

■ El ventilador no es orientable

Ulteriori informazioni e quote:
 ■ Ulérieures informations et cotes:
 ■ Further information and sizes:
 ■ Weitere Infos und Größen:
 ■ Más informaciones y medidas:

TIPO - Type		PESO Weight	PD ²	B	I	H	H1	H2	R	S	M	U
VENTILATORE Fan	MOTORE Motor	Kg	Kgf x m ²									
RL1250/6R	280 M6	1739	210	1818	565	1190	900	1500	45	1023	690	1688
RL1250/6	315 S6	1980	240	2030	675	1190	900	1500	45	1023	800	1798
RL1250/T		1258	240			1190	900	1500				

pg. / S. 3.6

pg. / S. 3.5

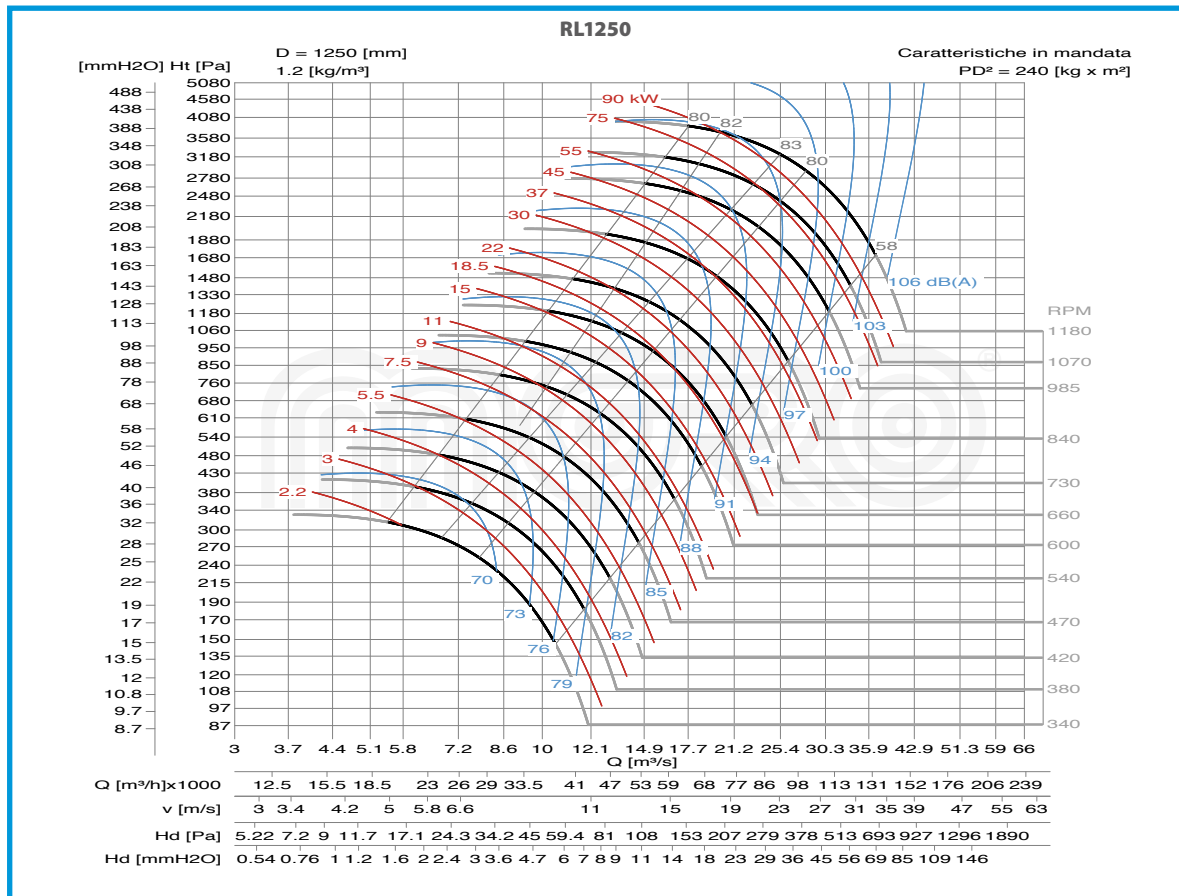
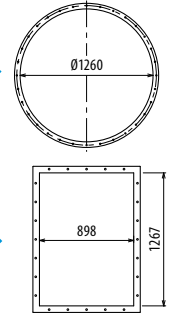

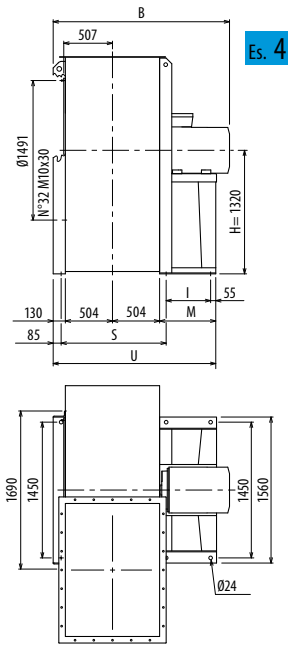

Es. 4

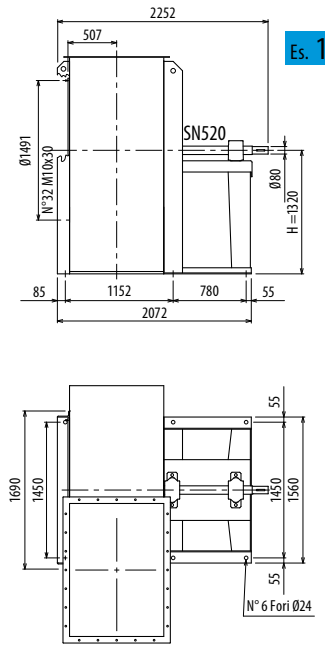

Es. 1

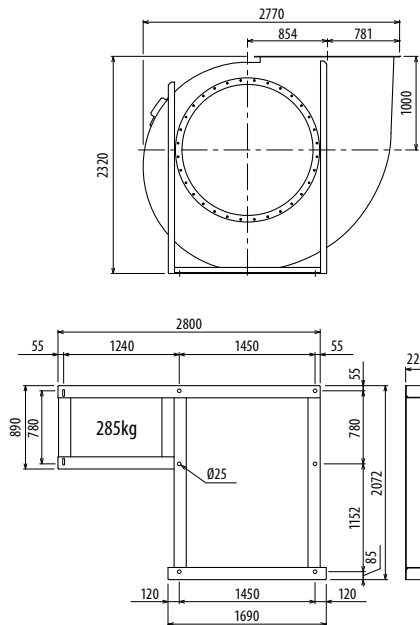

Il ventilatore non è orientabile • Peso in tabella comprensivo di motore

■ Le ventilateur n'est pas orientable ■ The fan is not revolvable

■ Der Ventilator ist nicht drehbar

■ El ventilador no es orientable

Ulteriori informazioni e quote:
 ■ Ulérieures informations et cotes:
 ■ Further information and sizes:
 ■ Weitere Infos und Größen:
 ■ Más informaciones y medidas:

TIPO • Type		PESO Weight	PD ²	B	I	H	H1	H2	H3	H4	M	S	U
VENTILATORE Fan	MOTORE Motor	Kg	Kgf x m ²										
RL1400/6R	315 M6	2630	379	2330	645	1320	1000	1700	1320	1700	800	1152	1937
RL1400/6	315 M6	2651	379	2330	645	1320	1000	1700	1320	1700	800	1152	1937
RL1400/T		1712	379			1320	1000	1700	1120	1500			

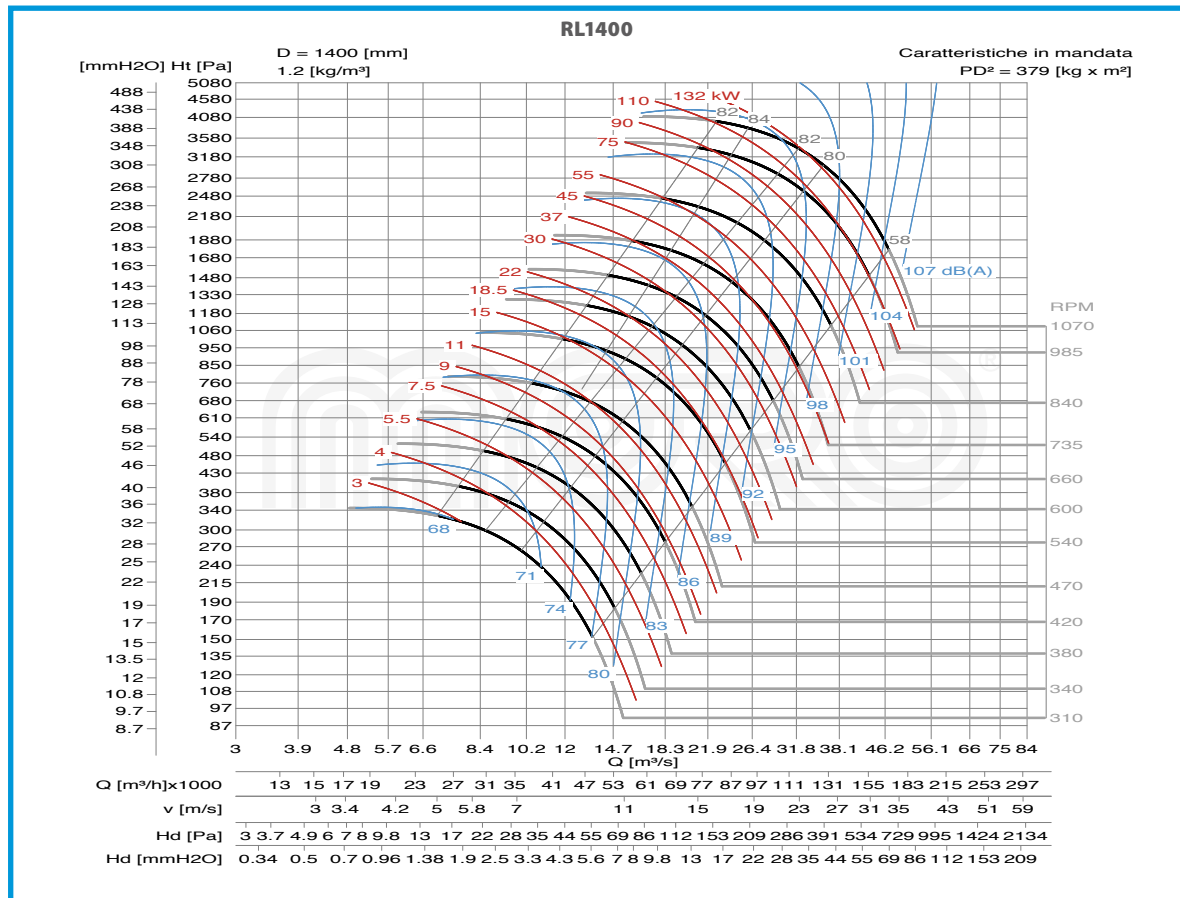
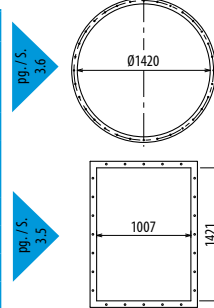

RD0 LG0

RD45 LG45

RD90 LG90

RD135 LG135

RD180 LG180

RD225 LG225

RD270 LG270

RD315 LG315

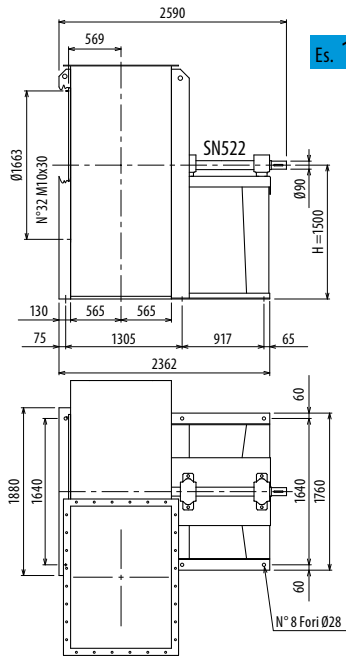

Es. 1

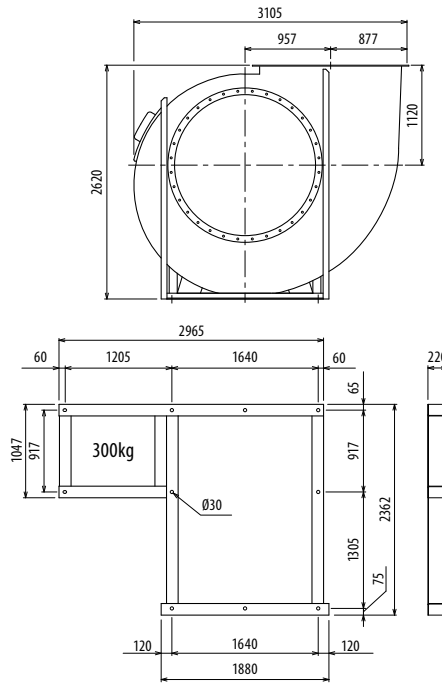

Ulteriori informazioni e quote:
 ■ Ulérieures informations et cotes:
 ■ Further information and sizes:
 ■ Weitere Infos und Größen:
 ■ Más informaciones y medidas:

Il ventilatore non è orientabile

■ Le ventilateur n'est pas orientable ■ The fan is not revolvable ■ Der Ventilator ist nicht drehbar ■ El ventilador no es orientable

TIPO - Type		PESO Weight	PD ²												
VENTILATORE Fan	MOTORE Motor	Kg	Kgf x m ²	B	I	H	H1	H2	H3	H4	M				
RL1600/T		2363	635			1500	1120	1900	1250	1600					

pg. / s.
3.6

pg. / s.
3.5

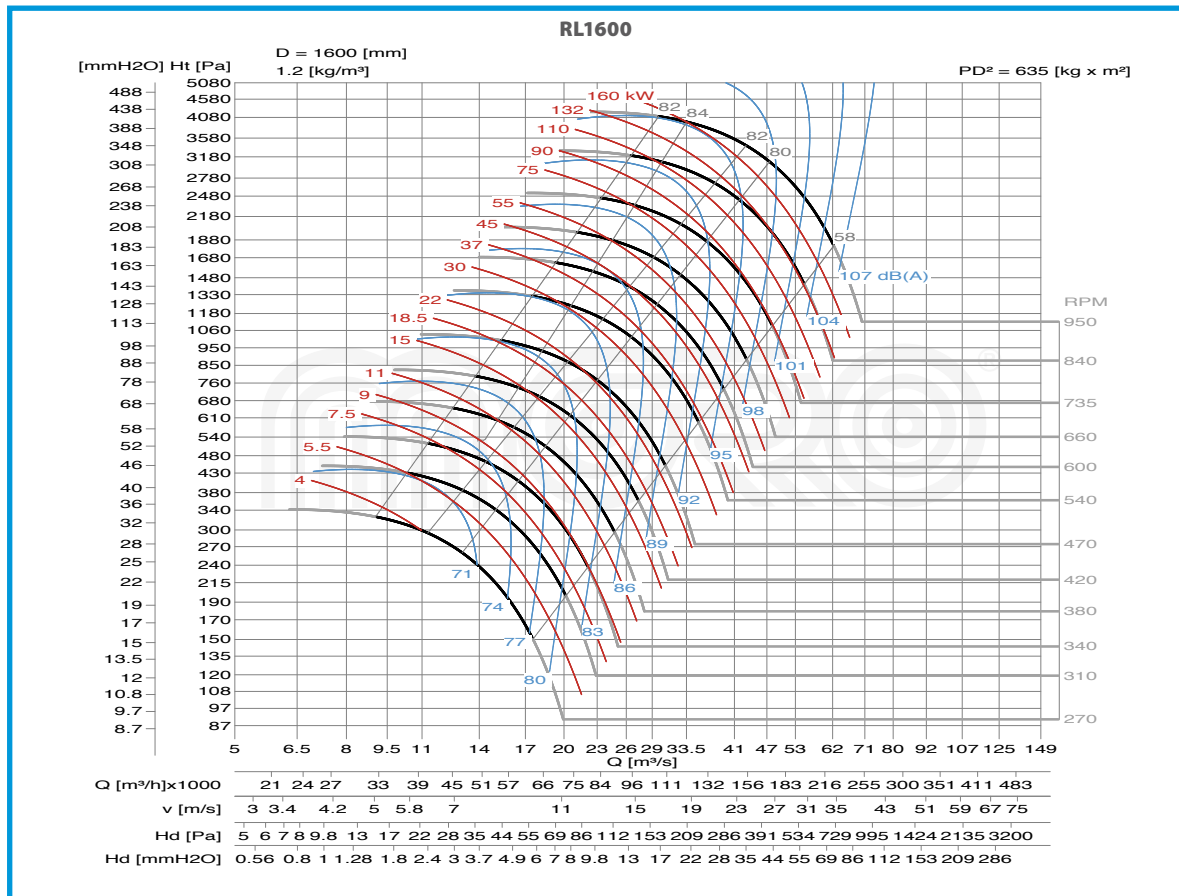
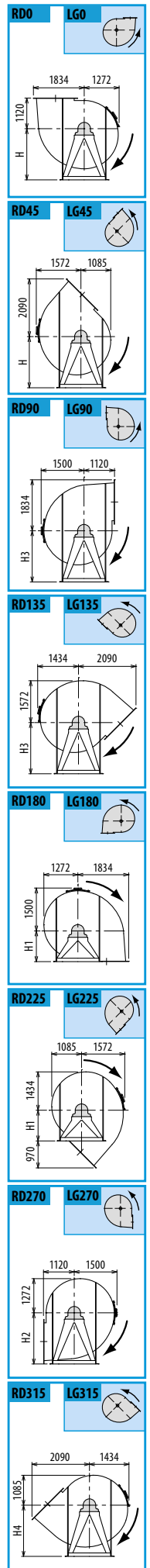
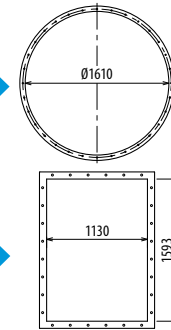

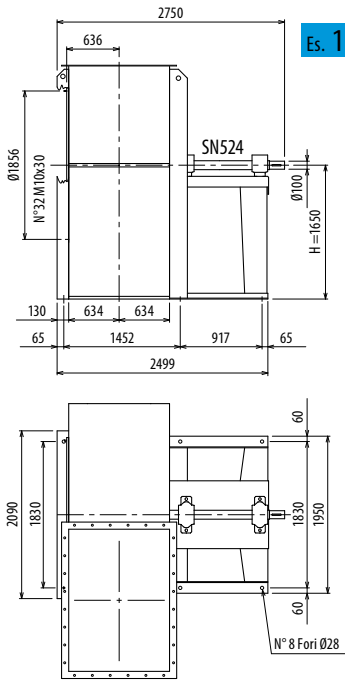

Es. 1

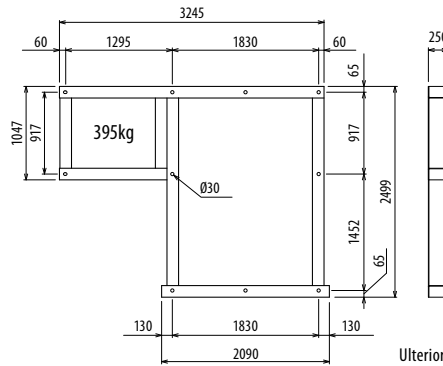
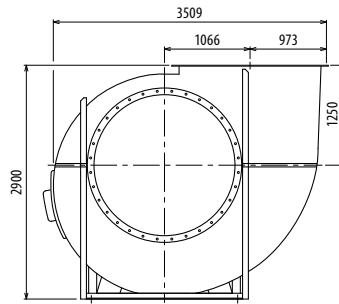

Ulteriori informazioni e quote:
 ■ Ulérieures informations et cotes:
 ■ Further information and sizes:
 ■ Weitere Infos und Größen:
 ■ Más informaciones y medidas:

Il ventilatore non è orientabile

■ Le ventilateur n'est pas orientable ■ The fan is not revolvable ■ Der Ventilator ist nicht drehbar ■ El ventilador no es orientable

TIPO - Type		PESO Weight	PD ²												
VENTILATORE Fan	MOTORE Motor	Kg	Kgf x m ²	B	I	H	H1	H2	H3	H4	M	H6			
RL1800/T		2912	1405			1650	1250	2120	1570	1400					

pg. / s. 3.6

pg. / s. 3.5

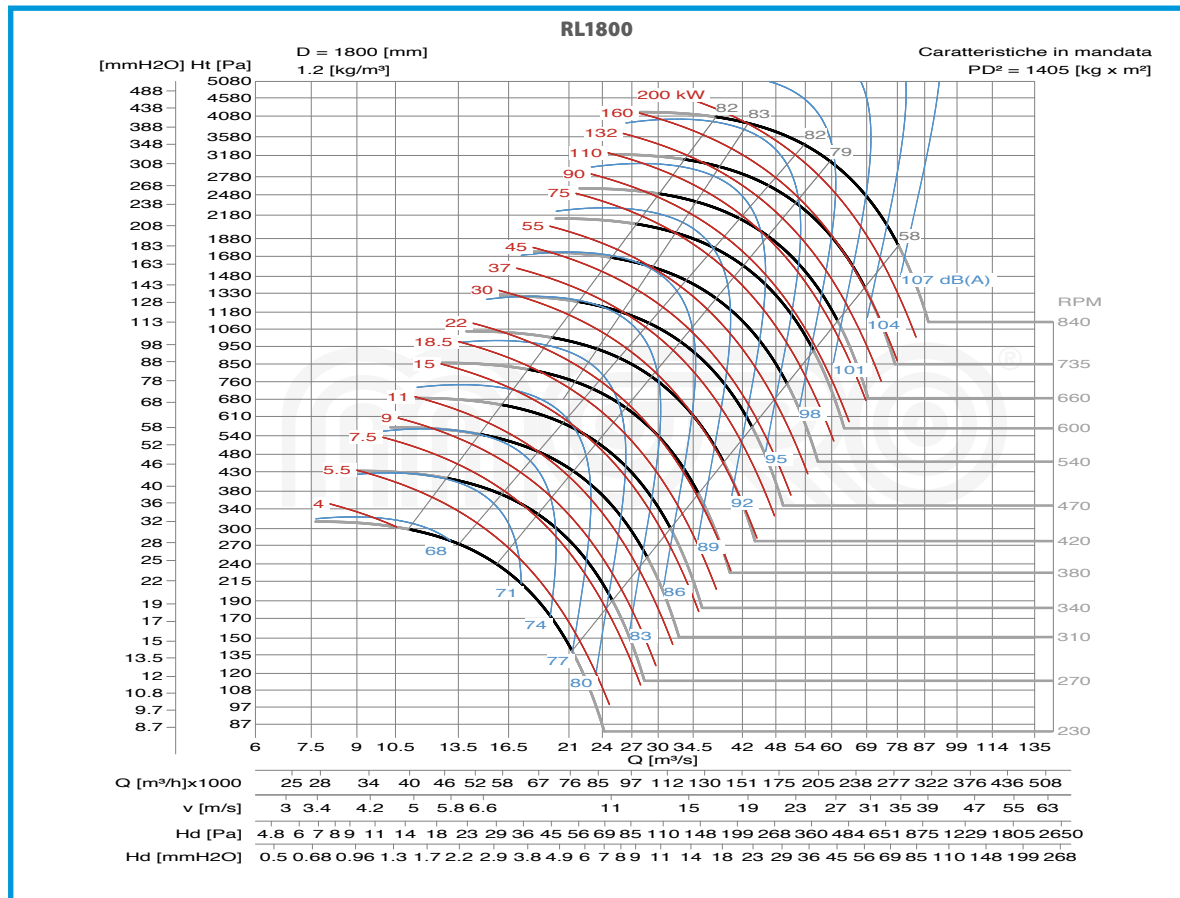
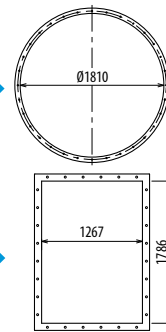

RD0 LG0

RD45 LG45

RD90 LG90

RD135 LG135

RD180 LG180

RD225 LG225

RD270 LG270

RD315 LG315

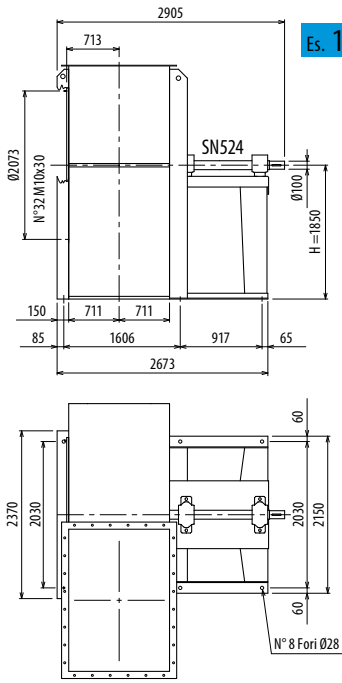

Es. 1

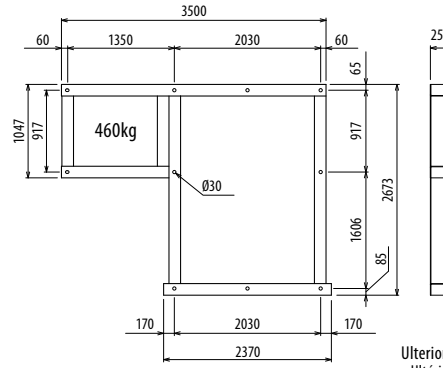
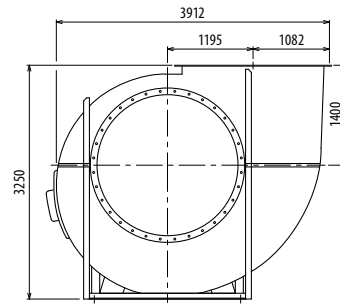

Ulteriori informazioni e quote:
 ■ Ulérieures informations et cotes:
 ■ Further information and sizes:
 ■ Weitere Infos und Größen:
 ■ Más informaciones y medidas:

Il ventilatore non è orientabile

■ Le ventilateur n'est pas orientable ■ The fan is not revolvable ■ Der Ventilator ist nicht drehbar ■ El ventilador no es orientable

TIPO - Type		PESO Weight	PD ²												
VENTILATORE Fan	MOTORE Motor	Kg	Kgf x m ²	B	I	H	H1	H2	H3	H4	M	H6			
RL2000/T		3413	2260			1850	1400	2360	1750	1600					

pg. / s.
3.6

pg. / s.
3.5

