

MHR

ASPIRATORE VENTILATORE CENTRIFUGO
CENTRIFUGAL FAN

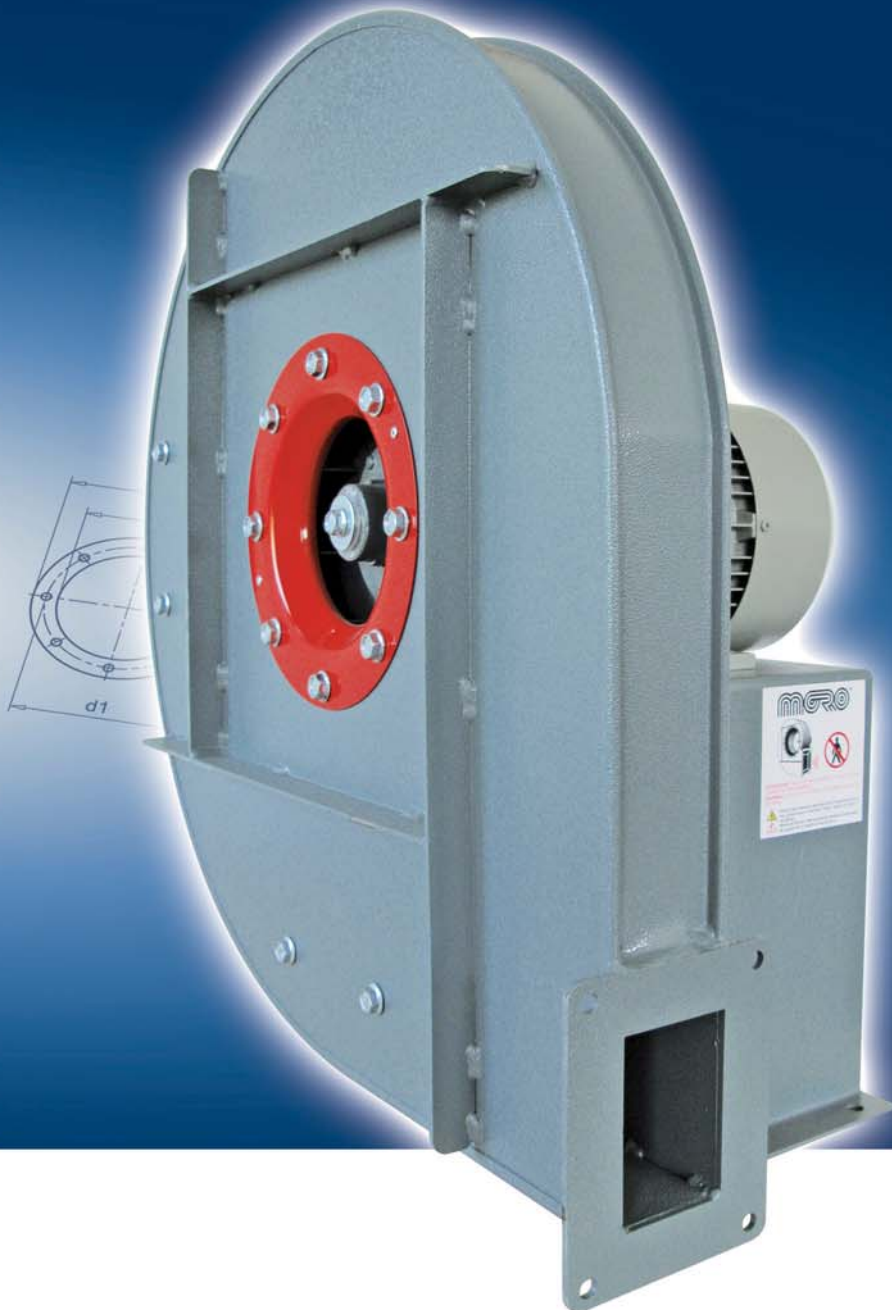

GIRANTE A PALE CURVE ROVESCE O RADIALI
BACKWARD CURVED OR RADIAL BLADES IMPELLER



ALTISSIMA PRESSIONE
VERY HIGH PRESSURE

Portata/Flow rate:
150 ÷ 3500 m³/h

Pressione/Pressure:
180 ÷ 1400 mm H₂O



MHR

ASPIRATORE VENTILATORE CENTRIFUGO CENTRIFUGAL FAN



I ventilatori della serie MHR sono indicati per l'utilizzo in tutti i campi in cui siano necessarie portate relativamente piccole con pressioni elevate di aria pulita.

L'esecuzione standard prevede l'utilizzo di coclee con profili bordati, telaio di base, giranti a pale rovesce tutti in acciaio al carbonio verniciati e l'installazione di motori elettrici a 2 poli.

I fluidi trasportati possono raggiungere una temperatura massima di 80°C in esecuzione standard; nel caso di esecuzioni speciali, sono ammessi valori massimi di 180°C. A richiesta sono disponibili esecuzioni in acciaio inossidabile; ventilatori della serie MHR sono fornibili anche in conformità alla direttiva ATEX (2014/34/UE).

MHR series blowers are suitable for all applications requiring quite small flow rates with high pressures of clean air.

Standard execution blowers are provided with edged steel sheets casings, carbon steel base frames, backward blades painted impellers and 2 poles electrical motors.

Transported fluids can reach maximum temperature of 80°C for standard execution; for special executions maximum values of 180°C are allowed.

On demand, special stainless steel execution are available;

MHR blowers are available also according to ATEX directive (2014/34/EU).



Esecuzione 4 (con basamento) - Arrangement 4 (with base frame)

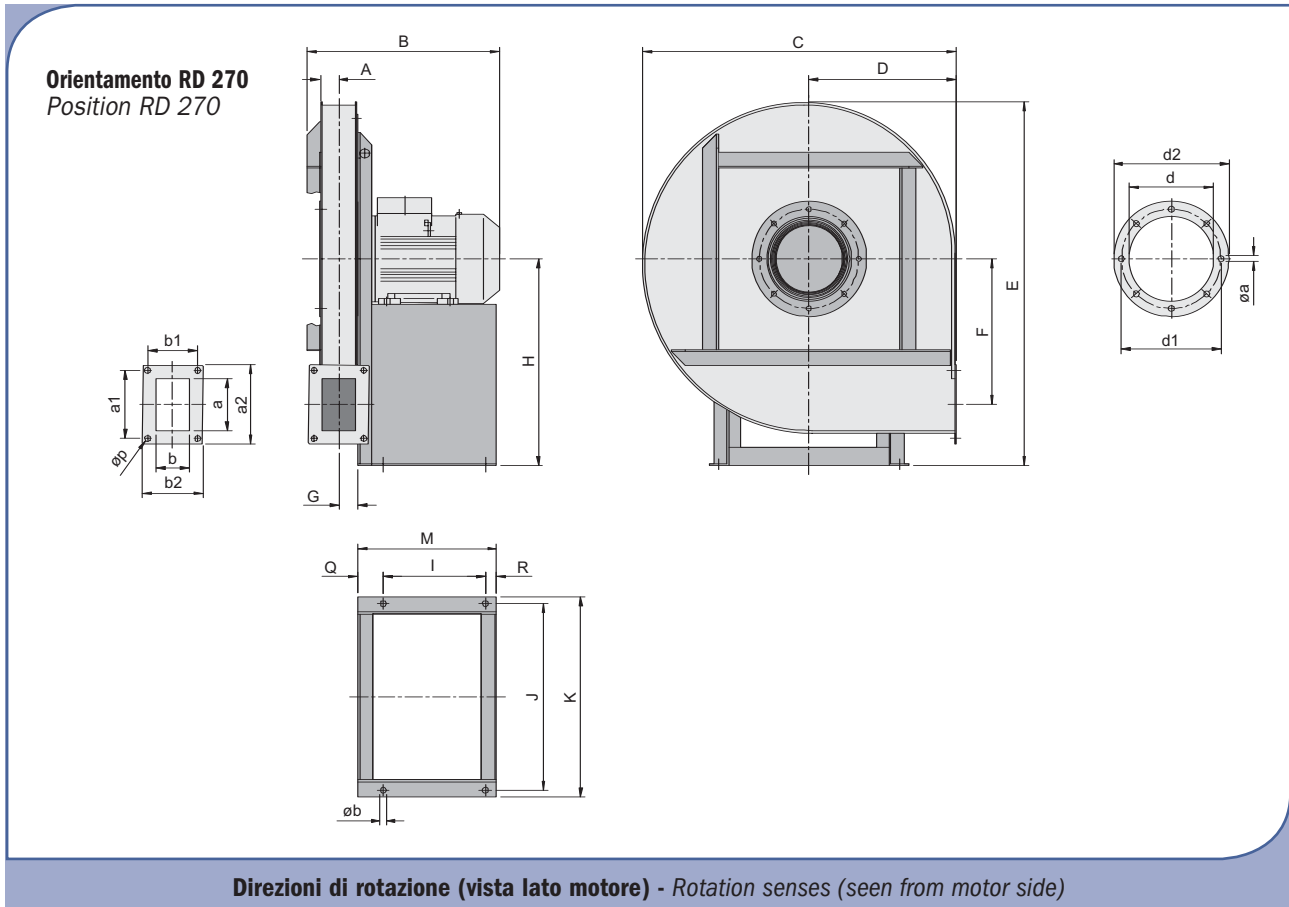

Direzioni di rotazione (vista lato motore) - Rotation senses (seen from motor side)

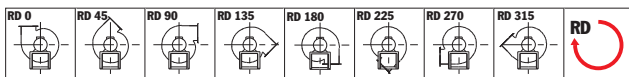

Rotazione oraria - Clockwise rotation sense

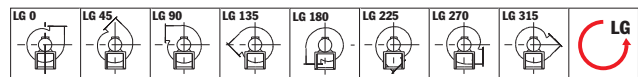

Rotazione anti-oraria - Anti-Clockwise rotation sense

Esecuzione 5 - Arrangement 5

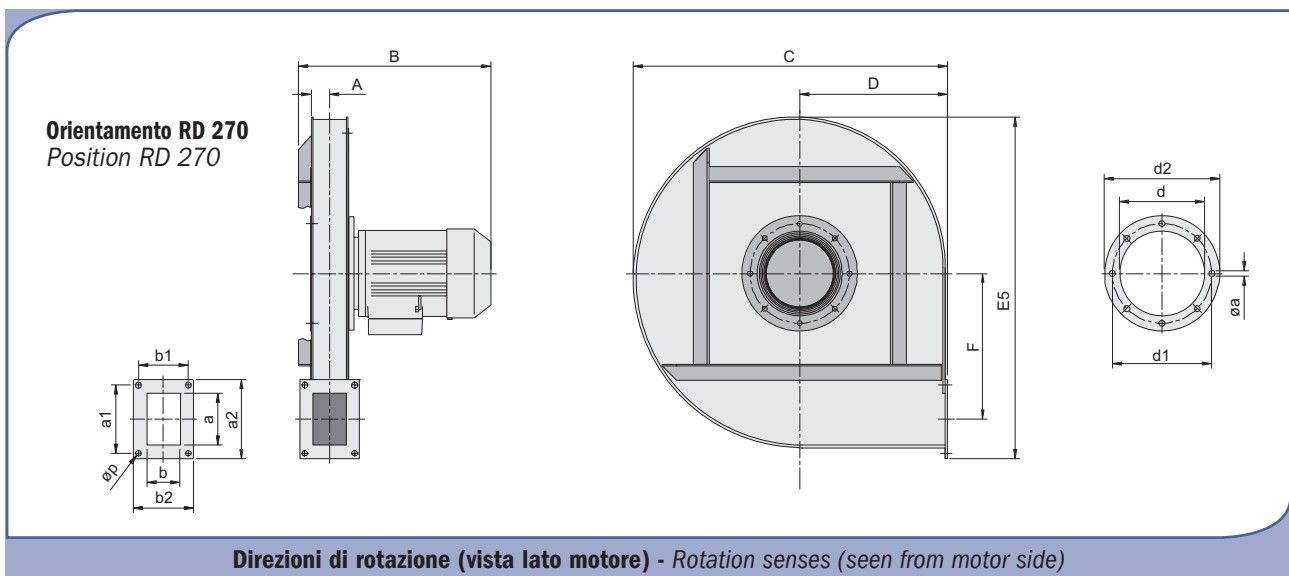

Direzioni di rotazione (vista lato motore) - Rotation senses (seen from motor side)

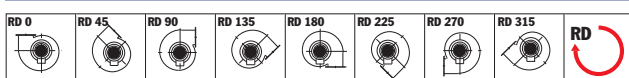

Rotazione oraria - Clockwise rotation sense

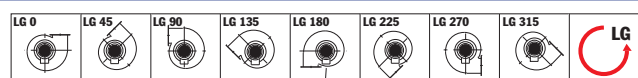

Rotazione anti-oraria - Anti-Clockwise rotation sense

DIMENSIONI D'INGOMBRO

OVERALL DIMENSIONS



Peso ventilatore in Kgf (completo di motore) - Weight of ventilator (complete with motor)

Nota: Quota B indicativa - Note: B quote indicative

TIPO - TYPE		kW inst.	PESO WEIGHT kgf	VENTILATORE FAN								
VENTILATORE FAN	MOTORE MOTOR			A	B	C	D	E	E5	F	G	H
MHR 350	71 M2	0,37	21	29	270	450	213	505	491	206	29	280
MHR 400	80 M2	0,75	28	32	300	515	243	572	567	240	32	315
MHR 451 MHR 452	80 M2 90 S2	0,75 1,5	30	36	320 340	570	266	660	627	266	36	375
MHR 501 MHR 502	90 S2 90 L2	1,5 2,2	57	40	345 370	630	295	730	690	294	40	415
MHR 561 MHR 562	90 L2 100 L2	2,2 3	80	44	380 410	692	325	800	753	321	44	455
MHR 631 MHR 632	112 M2 132 S2	4 5,5	140	48	435 465	780	367	895	849	365	48	505
MHR 671 MHR 672	132 S2 132 S2	5,5 7,5	163	51	475	830	390	950	902	390	51	535
MHR 711 MHR 712	132 S2 160 M2	7,5 11	210	53	480 610	867	408	990	944	407	53	555
MHR 761 MHR 762	160 M2 160 M2	11 15	270	62	625	948	445	1055	1030	445	62	580
MHR 811 MHR 812	160 L2 180 M2	18,5 22	320	80	710 730	1120	534	1250	1196	528	80	715

TIPO - TYPE	FLANGIA ASPIRANTE INLET FLANGE					FLANGIA PREMENTE OUTLET FLANGE										BASAMENTO BASE							
	VENTILATORE FAN	d	d ₁	d ₂	n°	∅a	a	b	a ₁	b ₁	a ₂	b ₂	n ₁ xp	n ₂ xp	n°	∅p	I	J	K	M	Q	R	∅b
MHR 350	121	151	180	8	11	64	44	94	76	120	102	-	-	4	11	135	210	240	210	50	25	11	11
MHR 400	135	165	195	8	11	74	50	110	88	140	110	-	-	4	11	175	250	280	250	50	25	11	11
MHR 451 MHR 452	152	182	217	8	11	92	58	130	96	152	118	-	-	4	11	175	290	320	250	50	25	11	11
MHR 501 MHR 502	168	200	235	8	11	102	65	140	102	162	125	-	-	4	11	225	350	390	305	55	25	11	11
MHR 561 MHR 562	187	219	254	8	11	114	73	150	110	174	133	-	-	4	11	225	400	440	305	55	25	11	11
MHR 631 MHR 632	209	241	278	8	11	127	82	160	120	187	142	-	-	4	11	300	440	480	380	55	25	11	11
MHR 671 MHR 672	233	265	300	8	11	134	87	170	126	194	147	-	-	4	11	300	440	480	380	55	25	11	11
MHR 711 MHR 712	233	265	300	8	11	142	92	182	132	204	154	-	-	4	11	300	480	520	380	55	25	13	13
MHR 761 MHR 762	250	282	310	8	11	160	110	190	140	220	170	-	1x95	6	11	300	480	520	380	55	25	13	13
MHR 811 MHR 812	250	292	330	8	11	200	144	240	180	265	210	1x95	2x95	10	11	330	420	460	410	55	25	13	13

MERO®

DIRETTAMENTE ACCOPPIATI CON MOTORE A 2 POLI DIRECT CONNECTION FOR 2 POLES MOTORS

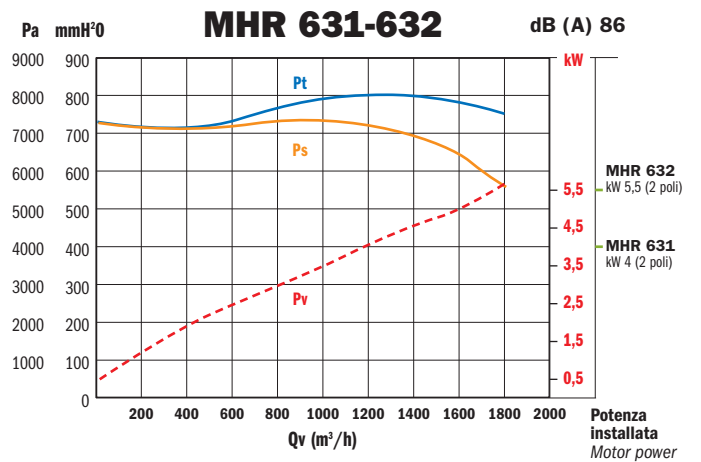
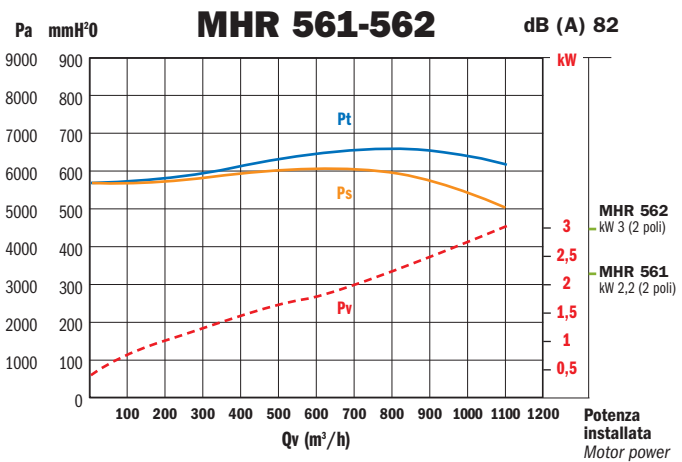
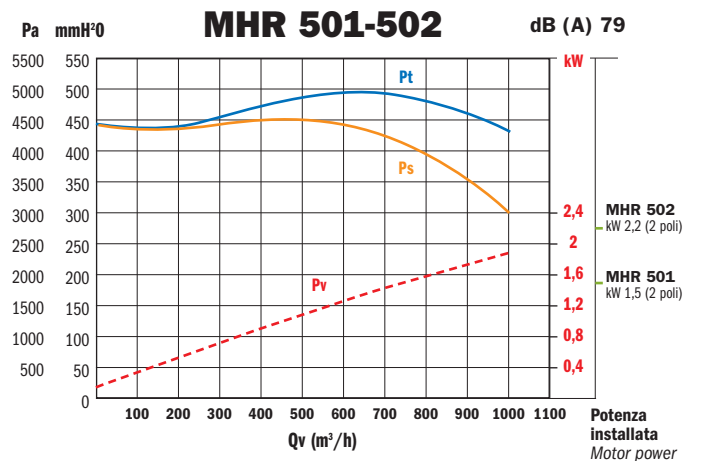
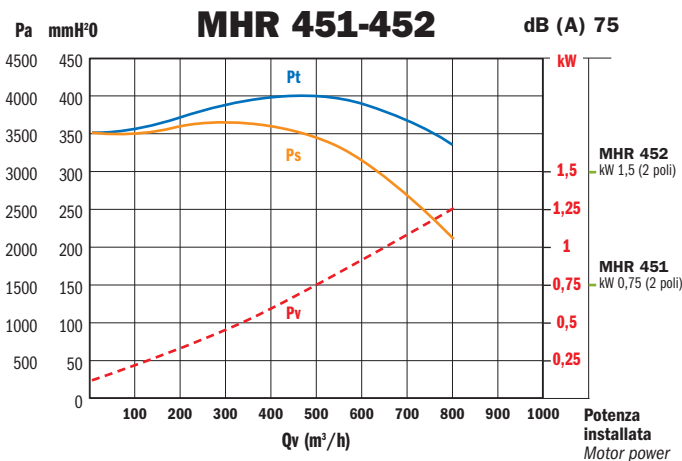
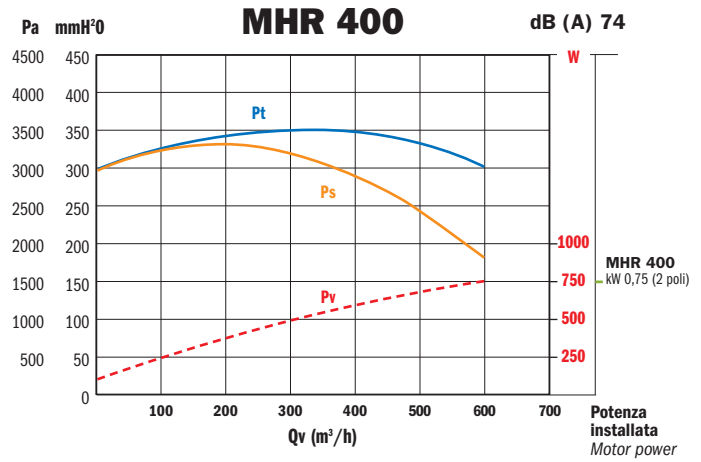
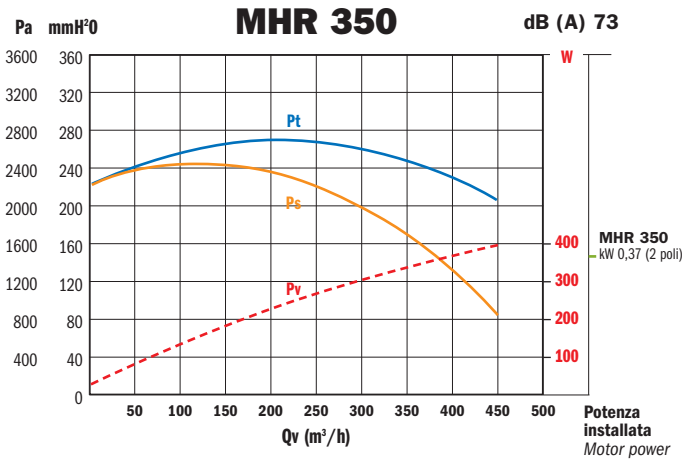

Valori riferiti a: / Datas referring to: **T=15°C; P=1 atm**

— Pt= Pressione totale - Total pressure
 — Ps= Pressione statica - Statical pressure
 - - - Pv= Potenza assorbita - Absorbed power

DIRETTAMENTE ACCOPPIATI CON MOTORE A 2 POLI

DIRECT CONNECTION FOR 2 POLES MOTORS

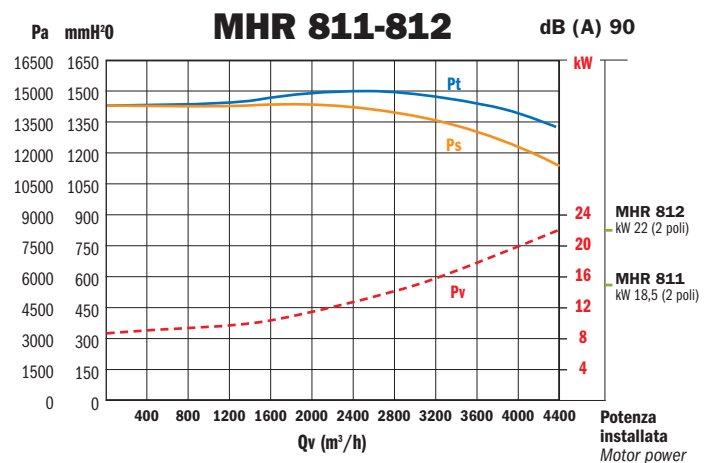
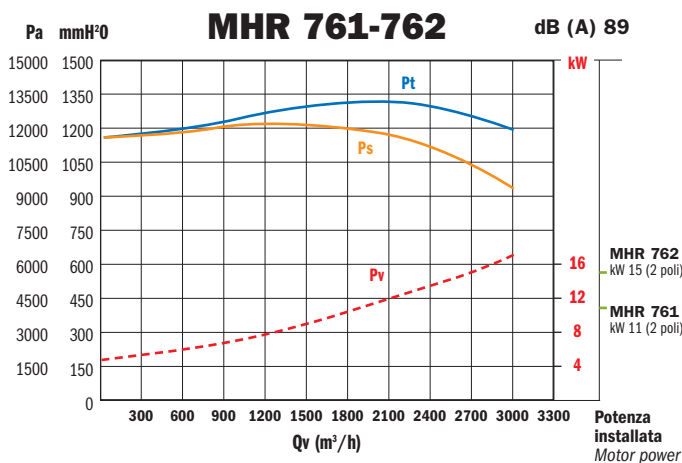
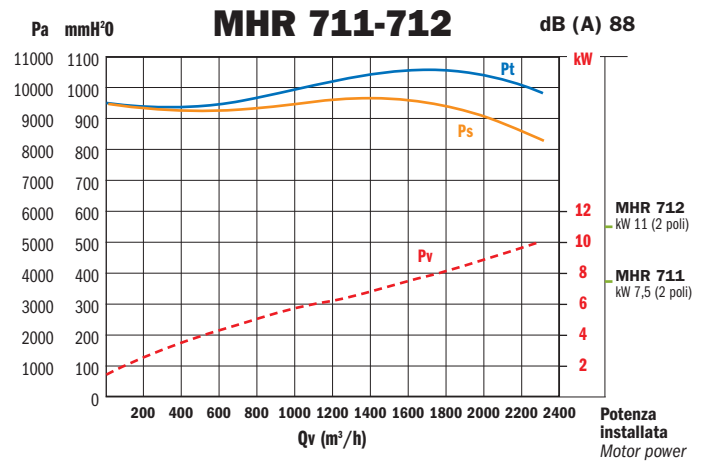
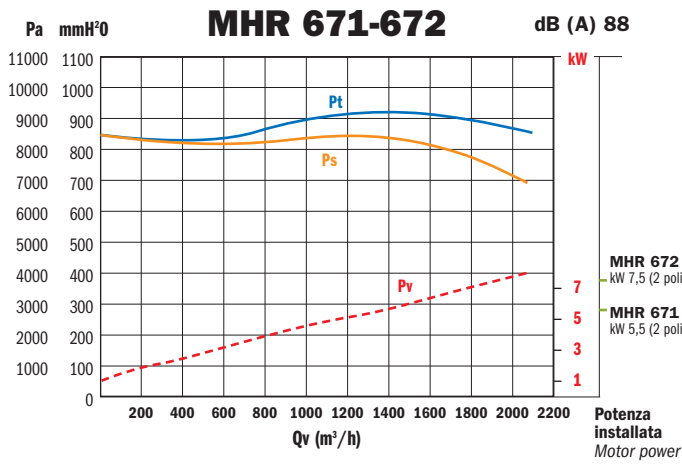

Valori riferiti a: / Datas referring to: T=15°C; P=1 atm

——— Pt= Pressione totale - Total pressure
 ——— Ps= Pressione statica - Statical pressure
 - - - - - Pv= Potenza assorbita - Absorbed power